

1



Combination spanner

AS-DRIVE



COLOR BOX

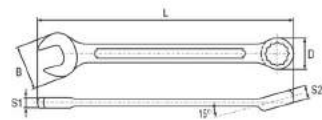

- application: workshop
- head offset: 15°
- surface finish: chromed, satin / mirror

YATO	Ø (mm)	L (mm)	S1 (mm)	S2 (mm)	PCS packing	
YT-00760	34	425	13	16	5	20
YT-00761	36	460	14	17.5	5	15
YT-00762	38	460	14	17.5	5	15
YT-00763	41	500	15	19	5	10
YT-00764	46	540	16.5	21	5	10
YT-00765	48	570	16.5	22	5	10
YT-00766	50	598	18	23.5	2	8
YT-00767	55	620	19	25	2	6
YT-00768	60	660	21	27	2	6
YT-00769	65	680	23	29	2	4

Combination spanner

CrV DIN 3113 ASORVE



COLOR BOX



- application: workshop
- head offset: 15°
- surface finish: chromed, satin / mirror



YATO	Ø (mm)	L (mm)	B (mm)	D (mm)	S1 (mm)	S2 (mm)	PCS packing	
YT-03349	5.5	110	14.8	10.5	3.7	4.9	10	300/600
YT-0335	6	110	14.8	10.5	3.7	4.9	10	300/600
YT-0336	7	120	16.1	11.3	4.0	5.3	10	300/600
YT-0337	8	130	18.5	12.9	4.2	5.0	10	180/360
YT-0338	9	140	20.5	14.6	4.2	5.0	10	180/360
YT-0339	10	150	22.2	16.2	4.9	6.4	10	180/360
YT-0340	11	160	25.5	17.3	4.9	7.0	10	180/360
YT-0341	12	170	26.7	18.7	5.3	7.6	10	120/240
YT-0342	13	180	28.0	19.6	5.5	8.2	10	120/240
YT-0343	14	190	30.3	21.4	5.9	7.7	10	50/100
YT-0344	15	200	32.8	22.8	6.2	8.5	10	50/100
YT-0345	16	210	33.9	23.7	6.1	9.1	10	50/100
YT-0346	17	220	35.9	24.7	6.5	9.1	10	50/100
YT-0347	18	230	37.8	26.9	6.9	10.0	10	50/100
YT-0348	19	235	38.9	27.7	7.0	10.1	10	50/100
YT-0349	20	250	41.4	29.2	7.3	11.0	10	40/80
YT-0350	21	260	43.4	31.0	7.1	10.9	10	40/80
YT-0351	22	270	45.9	32.2	8.1	11.2	5	20/40
YT-0352	23	280	47.8	34.3	7.8	11.1	5	20/40
YT-0353	24	290	49.9	34.8	9.2	11.2	5	20/40
YT-0354	25	300	51.2	36.6	9.2	12.4	5	20/40
YT-0355	26	310	53.2	37.4	9.2	12.9	5	20/40
YT-0356	27	320	55.9	39.3	9.3	12.7	5	15/30
YT-0357	28	330	56.5	40.9	9.9	13.5	5	15/30
YT-0358	29	340	60.0	42.4	10.0	13.6	5	15/30
YT-0359	30	350	60.9	43.8	10.0	14.7	5	10/20
YT-0360	32	370	64.5	46.6	11.3	14.9	5	10/20

1

Combination spanner set

6 PCS DIN 3113 CrV AS-DRIVE



8, 10, 12, 13, 14, 15 mm

YT-03605	490	6

Combination spanner set

7 PCS DIN 3113 CrV AS-DRIVE



8, 10, 12, 13, 14, 17, 19 mm

YT-03608	560	6

Combination spanner set

9 PCS DIN 3113 CrV AS-DRIVE



8, 10, 11, 12, 13, 14, 15, 17, 19 mm

YT-03612	900	6

Combination spanner set

6 PCS DIN 3113 CrV AS-DRIVE



8, 10, 12, 13, 14, 17 mm

YT-03606	580	6

Combination spanner set

7 PCS DIN 3113 CrV AS-DRIVE



10, 12, 13, 14, 15, 17, 19 mm

YT-03609	580	6

Combination spanner set

10 PCS DIN 3113 CrV AS-DRIVE



6, 8, 10, 11, 12, 13, 14, 15, 16, 17 mm

YT-03613	850	6

Combination spanner set

7 PCS DIN 3113 CrV AS-DRIVE



8, 10, 12, 14, 17, 19, 22 mm

YT-03610	890	6

Combination spanner set

8 PCS DIN 3113 CrV AS-DRIVE



8, 10, 12, 13, 14, 15, 17, 19 mm

YT-03611	830	6

Combination spanner set

10 PCS DIN 3113 CrV AS-DRIVE



10, 11, 12, 13, 14, 15, 16, 17, 18, 19 mm

YT-03615	1130	6

1

Combination spanner set

10 PCS DIN 3113 CrV AS-DRIVE



8,10,12,13,14,15,16,17,18,19 mm

YATO		
YT-03614	1120	6

Combination spanner set

14 PCS DIN 3113 CrV AS-DRIVE



8,9,10,11,12,13,14,15,16,17,18,19,22,24 mm

YATO		
YT-03618	1720	6

Combination spanner set

17 PCS DIN 3113 CrV AS-DRIVE

POUCH & COLOR BOX



8, 9, 10, 11, 12, 13, 14, 15, 16, 17, 18, 19, 22, 24, 27, 30, 32 mm

YATO		
YT-0363	3850	3

Combination spanner set

11 PCS DIN 3113 CrV AS-DRIVE



8,9,10,11,12,13,14,15,17,19,22 mm

YATO		
YT-03616	1180	6

Combination spanner set

12 PCS DIN 3113 CrV AS-DRIVE

POUCH & COLOR BOX



8, 9, 10, 11, 12, 13,14,15,17, 19, 22, 24 mm

YATO		
YT-0362	2500	6

Combination spanner set

23 PCS DIN 3113 CrV AS-DRIVE

POUCH & COLOR BOX



6,7,8,9,10,11,12,13,14,15,16,17,18,19,21,22,23,24,25, 27,29,30,32 mm

YATO		
YT-03651	4800	6

Combination spanner set

13 PCS DIN 3113 CrV AS-DRIVE



8,9,10,11,12,13,14,15,16,17,18,19,22 mm

YATO		
YT-03617	1470	6

Combination spanner set

12 PCS DIN 3113 CrV AS-DRIVE

POUCH & COLOR BOX



8, 9, 10, 11, 12, 13,14,15,16,17, 18,19 mm

YATO		
YT-03621	1500	6

Combination spanner set

25 PCS DIN 3113 CrV AS-DRIVE

POUCH & COLOR BOX



6,7,8,9,10,11,12,13,14,15,16,17,18,19,20,21,22,23,24, 25,26,27,28,30,32 mm

YATO		
YT-0365	5900	3

3

Combination spanner set

26 PCS DIN 3113 CrV AS-DRIVE

POUCH & COLOR BOX



6, 7, 8, 9, 10, 11, 12, 13, 14, 15, 16, 17, 18, 19, 20, 21, 22, 23, 24, 25, 26, 27, 28, 29, 30, 32 mm

YATO	5800	6
YT-03652		

Combination spanner set

6 PCS DIN 3113 CrV AS-DRIVE S.A.E.



5/16", 3/8", 7/16", 1/2", 9/16", 5/8"

YATO	510	6
YT-48860		

Combination spanner set

9 PCS DIN 3113 CrV AS-DRIVE S.A.E.



PLASTIC HANGER

1/4", 5/16", 3/8", 7/16", 1/2", 9/16", 5/8", 11/16", 3/4"

YATO	850	6
YT-48861		

Combination spanner

CrV DIN 3113 AS-DRIVE S.A.E.

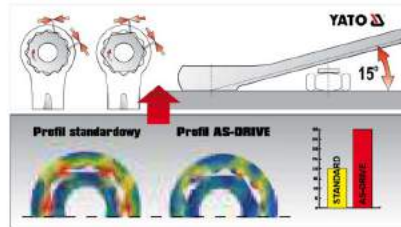
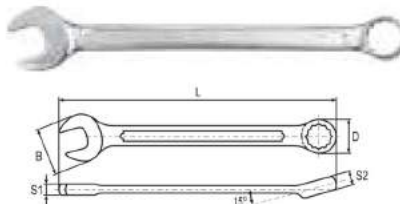

- application: workshop
- head offset: 15°
- surface finish: chromed, satin / mirror

COLOR BOX



YATO	Ø	L (mm)	B (mm)	D (mm)	S1 (mm)	S2 (mm)	PCS packing	
YT-4870	1/4"	110	13.9	10.7	4.0	4.9	10	300/600
YT-4871	5/16"	130	17.6	12.8	4.6	5.7	10	180/360
YT-4872	3/8"	150	21.5	15.5	4.8	6.1	10	180/360
YT-4873	7/16"	160	23.8	17.0	5.1	6.7	10	180/360
YT-4874	1/2"	180	27.6	19.9	5.6	8.0	10	120/240
YT-4875	9/16"	190	29.6	21.6	6.1	8.1	10	120/240
YT-4876	5/8"	210	33.6	23.9	6.3	9.2	10	50/100
YT-4877	11/16"	230	37.8	26.3	6.7	10.8	10	50/100
YT-4878	3/4"	240	40.1	27.9	7.2	10.6	10	50/100
YT-4879	13/16"	260	43.2	31.1	7.6	10.8	10	40/80
YT-4880	7/8"	270	46.5	32.9	8.4	11.6	5	20/40
YT-4881	15/16"	290	50.2	34.9	8.7	12.0	5	20/40
YT-4882	1"	300	51.9	36.2	8.8	12.7	5	20/40
YT-4883	1-1/16"	320	56.0	38.9	9.3	13.6	5	15/30
YT-4884	1-1/8"	340	59.7	42.2	9.8	14.2	5	15/30
YT-4885	1-1/4"	370	65.5	46.2	10.9	15.6	5	10/20

Combination spanner set

11 PCS CrV DIN 3113 AS-DRIVE S.A.E.



1/4", 5/16", 3/8", 7/16", 1/2", 9/16", 5/8", 11/16", 3/4", 13/16", 7/8"

YATO	1500	10
YT-48851		

14 PCS DIN 3113 CrV AS-DRIVE S.A.E.



3/8", 7/16", 1/2", 9/16", 5/8", 11/16", 3/4", 13/16", 7/8", 15/16", 1" 1-1/16", 1-1/8", 1-1/4"

YATO	3350	6
YT-48862		

Combination spanner set

16 PCS CrV DIN 3113 AS-DRIVE S.A.E.



YATO	Ø	L (mm)		
YT-48852	1/4"	110	3600	3
	5/16"	130		
	3/8"	150		
	7/16"	160		
	1/2"	180		
	9/16"	190		
	5/8"	210		
	11/16"	230		
	3/4"	235		
	13/16"	200		
	7/8"	270		
	15/16"	290		
	1"	300		
	1-1/16"	320		
1-1/8"	340			
1-1/4"	370			

Combination spanner

DIN 3113 CrV 6140 ASORIVE

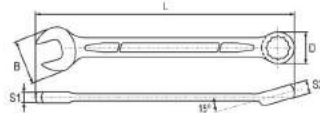

COLOR BOX

- application: industry
- head offset: 15°
- maximum torque exceeding DIN and ANSI standards by 60%
- surface finish: chromed, satin

YATO	Ø (mm)	L (mm)	B (mm)	D (mm)	S1 (mm)	S2 (mm)	PCS packing	
YT-0006	6	109	14.4	10.3	3.7	5.2	10	600
YT-0007	7	119	16.2	11.3	3.8	5.2	10	600
YT-0008	8	129	18.6	12.8	4.2	5.7	10	360
YT-0009	9	139	20.7	14.1	4.3	6.4	10	360
YT-0010	10	149	22.6	15.2	4.8	6.9	10	360
YT-0011	11	159	24.6	16.8	5.2	7.4	10	360
YT-0012	12	169	27.1	18.0	5.3	7.9	10	240
YT-0013	13	179	28.7	19.8	6.0	8.6	10	240
YT-0014	14	189	31.3	20.8	6.2	8.9	10	100
YT-0015	15	199	33.2	22.3	6.6	9.2	10	100
YT-0016	16	209	35.0	23.8	6.8	9.9	10	100
YT-0017	17	219	37.5	25.0	7.0	10.9	10	100
YT-0018	18	229	39.5	26.6	7.8	11.4	10	100
YT-0019	19	239	41.3	28.0	8.0	12.1	10	100
YT-0020	20	249	44.1	29.8	8.3	12.4	10	80
YT-0021	21	259	46.1	30.8	8.6	12.7	10	80
YT-0022	22	269	48.2	32.2	9.0	13.1	5	40
YT-0023	23	279	49.8	33.6	9.2	13.4	5	40
YT-0024	24	289	51.4	34.3	9.6	13.4	5	40
YT-0025	25	299	54.6	36.8	9.8	14.2	5	40
YT-0026	26	309	56.2	37.3	10.0	14.9	5	40
YT-0027	27	319	58.7	39.6	10.4	16.4	5	30
YT-0028	28	329	59.4	40.7	10.8	16.9	5	30
* YT-0029	29	339	60.9	41.7	11.0	17.4	5	30
YT-0030	30	349	63.0	43.3	11.3	18.4	5	30
YT-0032	32	369	67.3	44.8	11.8	19.4	4	24

Combination spanner set

10 PCS DIN 3113 CrV 6140 ASORIVE



6, 7, 8, 10, 12, 13, 14, 15, 17, 19 mm

YATO	1000	20
YT-0060		

Combination spanner set

12 PCS DIN 3113 CrV 6140 ASORIVE



8, 9, 10, 11, 12, 13, 14, 15, 17, 19, 22, 24 mm

YATO	1800	6
YT-0062		

Combination spanner set

15 PCS DIN 3113 CrV 6140 ASORIVE



6, 7, 8, 10, 11, 12, 13, 14, 15, 17, 18, 19, 22, 24, 27 mm

YATO	2500	8
YT-0065		

Combination spanner set

17 PCS DIN 3113 CrV 6140 ASORIVE



8, 9, 10, 11, 12, 13, 14, 15, 16, 17, 18, 19, 22, 24, 27, 30, 32 mm

YATO	4000	3
YT-0067		

Combination spanner set

25 PCS DIN 3113 CrV 6140 ASORIVE



6, 7, 8, 9, 10, 11, 12, 13, 14, 15, 16, 17, 18, 19, 20, 21, 22, 23, 24, 25, 26, 27, 28, 30, 32 mm

YATO	6200	3
YT-0075		

Combination spanner set

DIN 3113 CrV AS-DRIVE

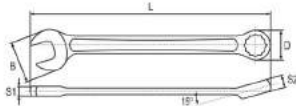

- application: industry
- head offset: 15°
- maximum torque exceeding DIN and ANSI standards by 60%
- surface finish: chromed, satin

YATO	Ø (mm)	L (mm)	B (mm)	D (mm)	S1 (mm)	S2 (mm)	PCS packing	
YT-5010	16	200	34.4	24.5	6.0	10.8	10	100
YT-5023	29	328	60.4	42.5	9.2	17.5	5	30

Stubby combination spanner

CrV

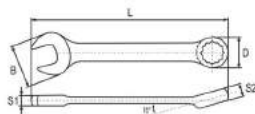

- application: workshop
- head offset: 15°
- surface finish: chromed

YATO	Ø (mm)	L (mm)	B (mm)	D (mm)	S1 (mm)	S2 (mm)	PCS packing	
YT-4901	8	91	19.2	13.9	5.0	6.3	10	120/240
YT-4902	9	97	21.7	16.4	5.4	6.4	10	120/240
YT-4903	10	97	21.9	16.6	5.2	6.4	10	120/240
YT-4904	11	100	23.2	18.3	5.9	7.2	10	120/240
YT-4905	12	108	27.4	20.2	6.4	7.6	10	120/240
YT-4906	13	109	27.9	20.7	6.7	7.7	10	120/240
YT-4907	14	115	29.3	22.1	6.1	8.3	10	60/120
YT-4908	15	120	31.2	24.0	6.8	9.6	10	60/120
YT-4909	16	121	32.0	24.3	6.8	9.6	10	60/120
YT-4910	17	128	36.6	27.1	7.4	9.9	10	60/120
YT-4911	18	127	36.2	26.8	7.4	9.9	10	60/120
YT-4912	19	135	39.2	29.5	8.8	10.8	10	60/120

Ratchet combination wrench

72T CrV AS-DRIVE

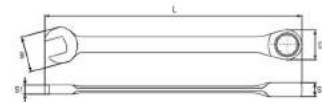

- application: service
- 72 teeth ratchet
- minimum operation angle: 5°
- surface finish: chromed, mirror

YATO	Ø (mm)	L (mm)	B (mm)	D (mm)	S1 (mm)	S2 (mm)	PCS packing	
YT-01906	6	126	14	13	4	6	10	50/100
YT-01907	7	139	16	16	5	6.5	10	50/100
YT-01908	8	140	17	18	5.5	7	10	50/100
YT-01909	9	151	20	21	6	7.5	10	50/100
YT-0191	10	160	22.1	22.2	6.0	7.8	10	50/100
YT-0192	11	165	24.7	24.2	6.6	8.5	10	50/100
YT-0193	12	170	26.4	25.5	6.7	8.9	10	50/100
YT-0194	13	180	27.5	26.7	6.6	9.2	10	50/100
YT-0195	14	190	30.8	29.0	7.4	9.4	10	50/100
YT-0196	15	200	32.9	30.8	7.7	10.1	10	50/100
YT-0197	16	210	34.3	31.5	7.8	10.3	10	50/100
YT-0198	17	225	36.8	33.6	8.4	10.6	10	50/100
YT-0199	18	235	39.2	35.6	9.1	10.8	10	50/100
YT-0200	19	245	40.1	37.3	9.5	11.3	10	50/100
YT-0189	21	290	45.2	43.0	9.9	13.3	6	30/60
YT-0201	22	290	45.6	44.2	10.5	13.4	6	24/48
YT-0202	24	335	52.8	50.0	11.3	14.5	6	48
YT-0203	25	335	52.0	47.4	10.2	14.3	6	48
YT-0204	27	355	55.6	52.7	10.9	15.7	6	30
YT-0205	30	400	62.5	57.7	12.2	17.1	6	24
YT-0206	32	420	65.0	61.7	13.2	17.9	6	24

Combination spanner set

7 PCS DIN 3113 CrV AS-DRIVE



10, 11, 12, 13, 14, 17, 19 mm

YATO	PCS packing	
YT-49125	570	6

1

Ratchet combination wrench set

5 PCS CrV 72T
AS-DRIVE



8,10,12,13,14 mm

YATO		
YT-02063	480	6

Ratchet combination wrench set

7 PCS CrV 72T
AS-DRIVE



8,10,12,13,14,15,18 mm

YATO		
YT-02066	830	6

Ratchet combination wrench set

8 PCS CrV 72T
AS-DRIVE



8,10,12,13,14,15,17,19 mm

YATO		
YT-02068	1050	6

Ratchet combination wrench set

5 PCS CrV 72T
AS-DRIVE



10,12,13,14,15 mm

YATO		
YT-02064	580	6

Ratchet combination wrench set

7 PCS CrV 72T
AS-DRIVE



10,11,12,13,14,15,17 mm

YATO		
YT-02067	1010	6

Ratchet combination wrench set

8 PCS CrV 72T
AS-DRIVE



10,11,12,13,14,15,17,19 mm

YATO	size(mm)
YT-3909	265x160x60

Ratchet combination wrench set

6 PCS CrV 72T
AS-DRIVE



8,10,12,13,14,17 mm

YATO		
YT-02065	690	6

Ratchet combination wrench set

7 PCS CrV 72T
AS-DRIVE



10, 12, 13, 14, 15, 17, 19 mm

YATO		
YT-0208		10/20

Ratchet combination wrench set

12 PCS CrV 72T
AS-DRIVE



8,9,10,11,12,13,14,15,16,17,18,19 mm

YATO		
YT-02069	1530	6

7

Non slip ratchet combination wrench



PLASTIC HANGER

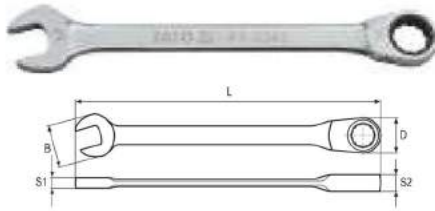

- application: industry
- 72 teeth ratchet
- minimum operation angle: 5°
- NON-SLIP system
- allows to unscrew 70% damaged hex screws
- surface finish: chromed, satin

YATO	Ø (mm)	L (mm)	B (mm)	D (mm)	S1 (mm)	S2 (mm)	PCS packing	
YT-0255	10	157	22.0	21.3	5.6	8.5	10	10/100
YT-0256	11	163	22.8	22.1	6.0	8.5	10	10/100
YT-0257	12	171	25.1	23.3	6.5	8.5	10	10/100
YT-0258	13	180	26.6	25.2	6.7	8.5	10	10/100
YT-0259	14	188	29.7	26.5	7.3	8.5	10	10/100
YT-0260	15	201	31.6	28.4	7.4	8.5	10	10/100
YT-0261	16	214	33.4	29.0	7.6	10.0	10	10/100
YT-0262	17	229	36.8	30.2	7.9	10.0	10	10/100
YT-0263	18	239	38.6	31.9	8.3	11.5	10	10/100
YT-0264	19	250	39.0	33.6	8.7	11.5	10	10/100

Ratchet combination wrench

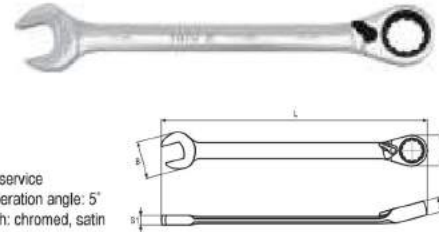

- application: service
- minimum operation angle: 5°
- surface finish: chromed, satin

YATO	Ø (mm)	L (mm)	B (mm)	D (mm)	S1 (mm)	S2 (mm)	PCS packing	
YT-1651	8	140	17.5	19.0	6.0	7.2	10	50/100
YT-1652	9	150	19.8	20.7	6.4	7.5	10	50/100
YT-1653	10	160	22.1	23.1	6.4	7.9	10	50/100
YT-1654	11	165	23.9	25.0	6.6	8.4	10	50/100
YT-1655	12	170	27.1	26.0	6.5	8.9	10	50/100
YT-1656	13	180	27.9	27.6	7.1	9.1	10	50/100
YT-1657	14	190	31.6	28.3	7.3	9.5	10	50/100
YT-1658	15	200	32.8	31.4	8.1	9.8	10	50/100
YT-1659	16	210	33.9	32.9	8.4	10.3	10	50/100
YT-1660	17	225	38.0	34.5	8.7	10.5	10	50/100
YT-1661	18	235	39.8	36.9	9.3	10.7	10	50/100
YT-1662	19	245	41.8	38.3	9.5	11.3	10	50/100
YT-1663	20	245	41.9	38.1	9.7	11.4	6	30/60
YT-1664	21	290	44.9	43.0	9.8	13.6	6	30/60
YT-1665	22	290	44.8	43.8	10.0	13.6	6	30/60
YT-1666	23	290	44.9	43.3	10.3	13.7	6	24/48
YT-1667	24	330	52.0	49.4	10.2	14.5	6	24/48
YT-1668	25	330	53.0	49.6	10.6	14.7	6	24/48
YT-1669	26	360	56.3	53.6	12.1	15.7	6	30
YT-1670	27	360	55.6	52.9	12.2	16.1	6	30
YT-1671	28	360	56.1	53.6	12.6	16.0	6	24
YT-1672	30	400	62.1	58.0	11.9	17.2	6	24
YT-1673	32	420	64.1	62.0	12.9	17.7	6	24

Rapid ratchet combination wrench

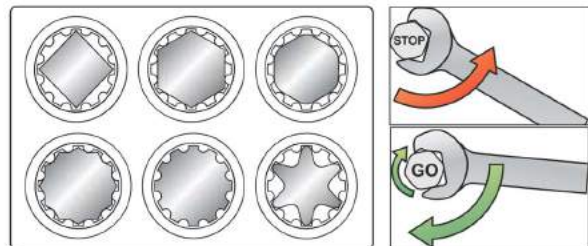
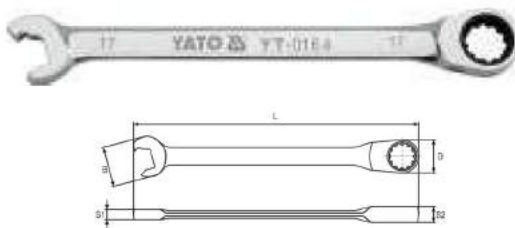

- application: industry
- 72 teeth ratchet
- minimum operation angle: 5°
- spline profile serves for 5 types of nuts
- allows to unscrew 70% damaged hex screws
- surface finish: chromed, mirror



YATO	Ø (mm)	L (mm)	B (mm)	D (mm)	S1 (mm)	S2 (mm)	PCS packing	
YT-0155	8	144	15.35	17.70	4.96	7.28	10	10/100
YT-0156	9	150	16.65	19.40	4.65	7.28	10	10/100
YT-0157	10	158	18.70	21.00	5.08	8.20	10	10/100
YT-0158	11	165	20.32	21.55	5.70	8.20	10	10/100
YT-0159	12	173	22.47	23.24	6.00	8.20	10	10/100
YT-0160	13	182	23.88	24.80	6.70	8.20	10	10/100
YT-0161	14	190	26.60	25.90	6.70	8.20	10	10/100
YT-0162	15	202	27.80	27.55	7.30	8.20	10	10/100
YT-0163	16	215	30.20	28.55	7.55	9.92	10	10/100
YT-0164	17	229	31.80	30.15	7.90	9.85	10	10/100
YT-0165	19	252	35.45	34.00	8.65	11.50	10	10/100

1

Ratchet combination wrench set

6 PCS CrV 72T



PLASTIC HANGER

8,10,12,13,14,16 mm

YATO		
YT-16733	660	6

Ratchet combination wrench set

8 PCS CrV 72T



PLASTIC HANGER

10,12,13,14,15,17,18 mm

YATO		
YT-16736	1050	6

Ratchet combination wrench set

6 PCS CrV 72T



PLASTIC HANGER

8,10,12,13,14,17 mm

YATO		
YT-16965	780	6

Ratchet combination wrench set

7 PCS CrV 72T



PLASTIC HANGER

10,12,13,14,15,17,19 mm

YATO		
YT-16734	1020	6

Ratchet combination wrench set

12 PCS CrV 72T



PLASTIC HANGER

8,9,10,11,12,13,14,15,16,17,18,19 mm

YATO		
YT-16737	1630	6

Ratchet combination wrench set

7 PCS CrV 72T



PLASTIC HANGER

10,12,13,14,15,17,19 mm

YATO		
YT-16966	1180	6

Ratchet combination wrench set

8 PCS CrV 72T



PLASTIC HANGER

8,10,12,13,14,15,17,19 mm

YATO		
YT-16735	1060	6

Ratchet combination wrench set

8 PCS CrV 72T



10,11,12,13,14,15,17,19mm

YATO	size(mm)
YT-3908	265x160x60

Ratchet combination wrench set

8 PCS CrV 72T



PLASTIC HANGER

8,10,12,13,14,15,17,19 mm

YATO		
YT-16967	1240	6

9

Ratchet combination wrench set



8,9,10,11,12,13,14,15,16,17,18,19 mm

YATO		
YT-16968	1830	6

Flexible ratchet combination wrench

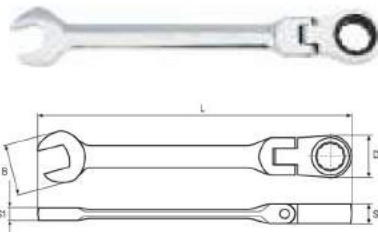

- application: service
- minimum operation angle: 5°
- surface finish: chromed, satin



YATO	O (mm)	L (mm)	B (mm)	D (mm)	S1 (mm)	S2 (mm)	PCS packing	
YT-1674	8	140	18.0	19.6	6.3	7.3	10	50/100
YT-1675	9	145	19.7	21.1	4.7	7.6	10	50/100
YT-1676	10	160	22.8	23.2	6.3	7.8	10	50/100
YT-1677	11	160	24.0	24.7	5.4	8.5	10	50/100
YT-1678	12	170	26.4	26.7	6.8	8.8	10	50/100
YT-1679	13	180	28.4	27.3	7.2	9.1	10	50/100
YT-1680	14	185	29.5	28.7	6.8	9.4	10	50/100
YT-1681	15	195	32.9	30.8	7.2	9.8	10	50/100
YT-1682	16	210	34.4	33.3	7.6	10.3	10	50/100
YT-1683	17	230	36.7	35.7	8.3	10.5	10	50/100
YT-1684	18	235	39.0	35.9	8.0	10.8	10	50/100
YT-1685	19	245	40.8	37.6	9.5	11.2	10	50/100
YT-1686	20	245	40.9	38.2	8.8	11.1	6	30/60
YT-1687	21	290	45.0	42.8	9.8	13.6	6	30/60
YT-1688	22	290	45.2	42.7	9.8	13.5	6	30/60
YT-1689	23	290	45.3	42.8	9.6	13.6	6	30/60
YT-1690	24	330	51.3	48.7	10.4	14.5	6	24/48
YT-1691	25	330	51.4	48.4	10.6	14.5	6	24/48
YT-1692	26	360	56.6	53.6	11.6	15.7	6	30
YT-1693	27	360	56.7	53.2	11.7	15.8	6	30
YT-1694	28	360	56.4	53.5	11.0	15.8	6	24
YT-1695	30	410	61.6	58.7	12.4	17.2	6	24
YT-1696	32	430	64.7	63.3	12.8	17.8	6	24

Flexible ratchet combination wrench



PLASTIC HANGER



- application: industry
- 72 teeth ratchet
- minimum operation angle: 5°
- articulated joint for ring head
- surface finish: chromed, mirror

YATO	O (mm)	L (mm)	B (mm)	D (mm)	S1 (mm)	S2 (mm)	PCS packing	
YT-0271	10	133	21.9	21.0	5.8	8.4	10	10/100
YT-0272	11	139	22.8	22.0	6.0	8.4	10	10/100
YT-0273	12	144	25.3	23.6	6.0	8.4	10	10/100
YT-0274	13	152	27.1	24.9	6.6	8.4	10	10/100
YT-0275	14	157	29.8	26.5	7.3	8.4	10	10/100
YT-0276	15	167	31.6	27.7	7.4	8.4	10	10/100
YT-0277	16	177	33.7	29.1	7.6	10.0	10	10/100
YT-0278	17	187	37.0	30.5	8.0	10.0	10	10/100
YT-0279	18	201	39.0	31.7	8.4	11.5	10	10/100
YT-0280	19	213	39.7	34.2	8.5	11.5	10	10/100

Reversible half-moon spanner



PLASTIC HANGER

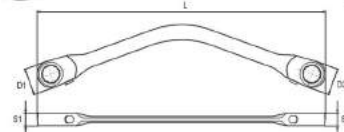

- application: industry
- minimum operation angle: 5°
- direction switch
- excellent for work in tight spaces
- used for dismantling of collector tubes, alternators and starters
- surface finish: chromed, mirror

YATO	O (mm)	L (mm)	D1 (mm)	D2 (mm)	S1 (mm)	S2 (mm)	
YT-0283	10x11	192	21.0	21.9	8.4	8.4	10/100
YT-0284	12x15	206	23.6	28.2	8.4	8.4	10/100
YT-0285	13x14	229	25.4	27.0	8.4	8.4	10/100
YT-0286	16x18	247	28.6	31.7	10.0	11.5	10/100
YT-0287	17x19	260	29.7	33.8	10.0	11.5	10/100

1

Double ratchet spanner

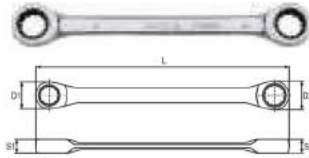

- minimum operation angle: 5°
- 72 teeth ratchet
- surface finish: chromed, mirror

YATO	Ø (mm)	L (mm)	D1 (mm)	D2 (mm)	S1 (mm)	S2 (mm)	PCS packing	
YT-5030	8x9	125	18.4	20.2	7.2	7.5	5	100/200
YT-50305	8x10	130	18.3	21.5	7.2	7.8	5	100/200
YT-5031	10x11	150	21.9	23.9	8.0	8.5	5	100/200
YT-5032	12x13	170	25.4	26.5	8.9	9.0	5	100/200
YT-5033	14x15	190	27.7	29.6	9.5	9.8	5	50/100
YT-5034	16x18	210	31.2	34.8	10.0	10.8	5	50/100
YT-5035	17x19	235	32.5	35.7	10.5	11.8	5	50/100

Double ratchet spanner set



8x9, 10x11, 12x13, 14x15, 16x18, 17x19 mm

YATO	Weight (g)	PCS
YT-50356	890	6

Insert adapter for gear wrench

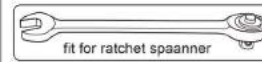

fit for ratchet spanner



- can fit 1/4", 3/8", 1/2" sockets
- quick release
- the head can 180 rotate

YATO	size	fit for spanner (mm)	PCS
YT-07531	1/4" (6.3mm)	10	1/300
YT-07532	3/8" (9.5mm)	13	1/300
YT-07533	1/2" (12.7mm)	19	1/300

Double ratchet spanner set



8x9, 10x11, 12x13, 14x15, 17x19 mm

YATO	PCS packing	Weight (g)
YT-5038	1	10/30

Half-moon spanner

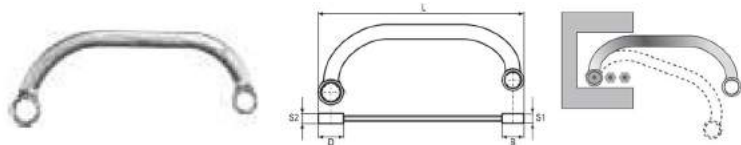

- application: industry
- excellent for work in tight spaces
- used for dismantling of collector tubes, alternators and starters
- surface finish: chromed, satin



YATO	Ø (mm)	L (mm)	B (mm)	D (mm)	S1 (mm)	S2 (mm)	Weight (g)
YT-0170	10x12	145	16.8	19.2	6.8	6.8	10/60
YT-0171	11x13	170	18.5	21.2	8.4	8.6	10/60
YT-0172	14x15	195	22.8	25.8	9.2	9.9	10/60
YT-0173	16x17	220	26.2	28.6	9.9	10.5	10/60
YT-0175	19x22	260	28.7	32.9	10.4	10.9	10/60

Double ratchet spanner set



8x10, 12x13, 14x15, 16x18, 17x19 mm

YATO	Weight (g)	PCS
YT-50355	840	6

Torx ring spanner set



- minimum operation angle: 5°
- 72 teeth ratchet
- surface finish: chromed, mirror

YATO	Size (mm)	L (mm)	Weight (g)	PCS
YT-0530	E6xE8	112	425	10/60
	E10xE12	140		
	E14xE18	180		
	E20xE24	224		

Double open end spanner set



6x7, 8x10, 11x13, 12x14, 17x19, 21x23 mm

YATO	Weight (g)	PCS
YT-48180		6

Double open end spanner

DIN 3110 CrV

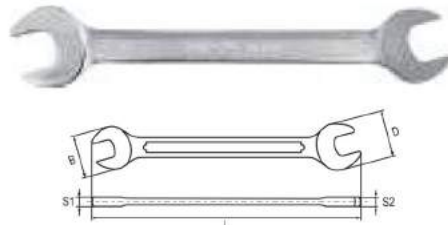

• surface finish:
chromed, satin / mirror



YATO	Ø (mm)	L (mm)	B (mm)	D (mm)	S1 (mm)	S2 (mm)	PCS (SET)	Box
YT-4800	5.5x7	120	14.3	16.6	4.0	4.0	10	300/600
YT-0367	6x7	120	15.1	16.8	3.5	3.6	10	360/720
YT-03671	7x9	140	18.7	20.8	3.7	3.6	10	180/360
YT-0368	8x9	140	18.7	20.8	3.7	3.6	10	180/360
YT-4801	8x10	140	18.1	20.6	4.5	4.5	10	150/300
YT-4802	9x11	155	22.2	24.8	4.8	4.8	10	150/300
YT-0369	10x11	155	22.4	25.5	4.6	4.6	10	150/300
YT-4803	10x12	155	22.7	25.4	4.9	5.0	10	150/300
YT-0332	10x13	170	22.5	29.3	4.6	5.3	10	150/300
YT-4804	11x13	170	25.3	28.2	5.2	5.2	10	80/160
YT-0370	12x13	170	27.1	29.3	4.9	5.3	10	80/160
YT-4805	12x14	170	26.7	29.4	5.3	5.0	10	80/160
YT-4806	13x15	185	31.2	33.4	6.0	5.9	10	80/160
YT-4807	13x16	185	31.0	33.3	6.0	5.8	10	80/160
YT-0333	13x17	180	29.3	37.5	5.3	6.3	10	50/100
YT-0371	14x15	180	31.0	33.0	5.3	5.4	10	80/160
YT-4808	14x17	190	28.9	37.0	5.7	5.7	10	50/100
YT-0372	16x17	200	34.9	37.5	6.5	6.3	10	50/100
YT-4809	16x18	200	34.6	37.4	6.2	6.1	10	50/100
YT-0334	17x19	220	37.5	38.7	6.3	6.3	10	50/100
YT-0373	18x19	220	38.7	41.0	6.6	6.3	10	50/100
YT-4810	19x21	235	42.4	47.1	6.7	6.6	10	30/60
YT-4811	19x22	235	42.5	47.2	6.6	6.6	10	30/60
YT-0374	20x22	230	42.1	46.8	7.1	6.8	10	30/60
YT-0375	21x23	245	44.4	48.6	7.3	6.9	10	30/60
YT-4812	22x24	250	46.7	51.3	7.6	8.0	10	20/40
YT-4813	23x26	260	51.9	56.6	8.4	8.3	5	20/40
YT-0376	24x27	260	51.6	56.9	8.1	8.1	5	20/40
YT-0377	25x28	270	52.3	57.9	8.4	8.3	5	20/40
YT-4814	27x30	280	56.9	63.2	8.6	9.0	5	15/30
YT-0378	30x32	295	61.4	65.1	8.0	8.6	5	15/30
YT-4815	30x34	285	64.2	68.9	11.4	11.0	5	15/30
YT-4816	32x34	285	63.7	68.6	11.3	11.0	5	10
YT-4817	34x36	280	63.8	68.6	11.3	11.1	5	10

Double open end spanner set

8 PCS DIN 3110 CrV



5.5x7, 8x10, 10x12, 12x14, 14x17, 17x19, 19x22, 22x24 mm

YATO	1040	6
YT-48181		

Double open end spanner set

10 PCS DIN 3110 CrV



5.5x7, 8x10, 9x11, 10x12, 12x14, 14x17, 17x19, 19x22, 24x27, 30x32 mm

YATO	1730	6
YT-48182		

Double open end spanner set

10 PCS DIN 3110 CrV



6x7, 8x9, 10x11, 12x13, 14x15, 16x17, 18x19, 20x22, 21x23, 24x27 mm

YATO	1600	6
YT-0380		

Double open end spanner set

12 PCS DIN 3110 CrV



6x7, 8x9, 10x11, 12x13, 14x15, 16x17, 18x19, 20x22, 21x23, 24x27, 25x28, 30x32 mm

YATO	2500	8
YT-0381		

Double open end spanner set

13 PCS DIN 3110 CrV



6x7, 8x10, 10x12, 11x13, 12x14, 14x17, 17x19, 19x21, 21x23, 22x24, 23x26, 24x27, 30x32 mm

YATO	2640	6
YT-48183		

1 Double open end spanner

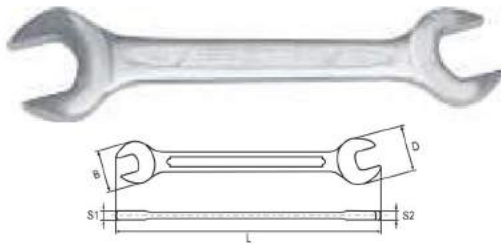

- application: service
- head offset: 15°
- surface finish: chromed, satin



YATO	O (mm)	L (mm)	B (mm)	D (mm)	S1 (mm)	S2 (mm)	PCS packing	
YT-01320	36x41	321	82	70	12.2	12.2	5	20
YT-01321	41x46	371	92	82	13.2	13.2	5	15
YT-01322	46x50	403	102	92	13.8	13.8	5	15
YT-01323	50x55	443	102	102	15.2	15.2	5	10

Double open end spanner

DIN 3110 CrV 6140

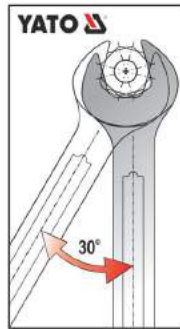
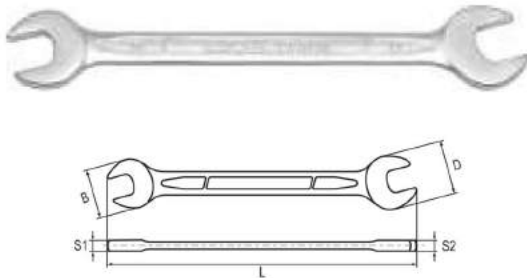

- head offset: 5°
- maximum torque exceeding DIN and ANSI standards by 60%
- surface finish: chromed, satin



YATO	O (mm)	L (mm)	B (mm)	D (mm)	S1 (mm)	S2 (mm)	PCS packing	
YT-0107	6x7	128	15.5	17.5	3.8	3.8	10	600
YT-0109	8x9	146	19.4	21.4	4.3	4.3	10	360
YT-0110	8x10	146	19.4	21.4	4.3	4.3	10	360
YT-0111	10x11	162	23.5	25.7	5.0	5.0	10	360
YT-0112	10x13	175	27.7	30.2	5.3	5.3	10	120
YT-0113	12x13	175	27.7	30.2	5.3	5.3	10	120
YT-0115	14x15	191	31.7	33.7	5.8	5.8	10	120
YT-0117	13x17	195	31.7	38.7	6.2	6.2	10	120
YT-0118	16x17	212	36.2	38.2	6.3	6.3	10	100
YT-0119	17x19	224	40.2	42.2	6.8	6.8	10	100
YT-0120	18x19	224	40.2	42.2	6.8	6.8	10	100
YT-0122	19x22	237	44.2	48.2	7.5	7.5	10	60
YT-0123	20x22	237	44.2	48.2	7.5	7.5	10	60
YT-0125	21x23	247	46.2	50.2	7.8	7.8	10	60
YT-0127	24x27	268	53.2	57.7	8.4	8.4	5	40
YT-0128	25x28	268	53.2	57.7	8.4	8.4	5	40
YT-0132	30x32	295	64.2	68.2	9.4	9.4	5	40

Double open end spanner set

7 PCS DIN 3110 CrV 6140



6x7, 8x9, 10x11, 12x13, 14x15, 16x17, 18x19 mm

YATO		
YT-0147	800	20

Double open end spanner set

10 PCS DIN 3110 CrV 6140



6x7, 8x9, 10x11, 12x13, 14x15, 16x17, 18x19, 20x22, 21x23, 24x27 mm

YATO		
YT-0150	1700	6

Double open end spanner set

12 PCS DIN 3110 CrV 6140



6x7, 8x9, 10x11, 12x13, 14x15, 16x17, 18x19, 20x22, 21x23, 24x27, 25x28, 30x32 mm

YATO		
YT-0152	2600	8

Double open end spanner

DIN 3110 CrV S.A.E.

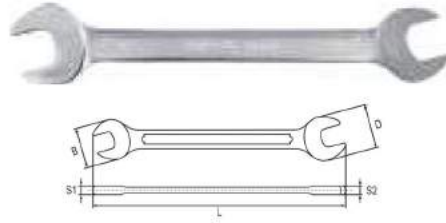

• surface finish:
chromed, satin / mirror



COLOR BOX

YATO	Ø	L (mm)	B (mm)	D (mm)	S1 (mm)	S2 (mm)	PCS packing	
YT-4830	1/4" x 5/16"	120	14.8	17.2	3.9	3.9	10	150/300
YT-4831	3/8" x 7/16"	155	22.0	25.1	4.8	4.8	10	150/300
YT-4832	1/2" x 9/16"	185	31.2	33.4	5.8	5.8	10	80/160
YT-4833	5/8" x 11/16"	200	34.6	37.2	6.0	6.1	10	50/100
YT-4834	11/16" x 3/4"	220	38.7	41.2	7.0	7.0	10	50/100
YT-4835	13/16" x 7/8"	235	42.7	47.0	7.0	7.0	10	20/40
YT-4836	15/16" x 1"	260	51.5	56.5	8.3	8.4	5	10
YT-4837	1-1/8" x 1-1/4"	295	62.6	66.2	8.6	8.7	5	10

Bi-hexagonal ring spanner

DIN 838 CrV AS-DRIVE

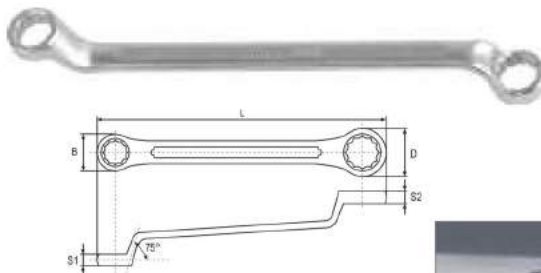

COLOR BOX



• application: industry
• surface finish: chromed, satin / mirror

YATO	Ø (mm)	L (mm)	B (mm)	D (mm)	S1 (mm)	S2 (mm)	PCS packing	
YT-4840	5.5x7	165	11.1	12.4	5.4	4.9	10	300/600
YT-0383	6x7	165	11.0	12.7	5.4	5.5	10	200/400
YT-0384	8x9	185	13.9	15.5	6.8	7.2	10	100/200
YT-4841	8x10	180	13.6	15.3	6.1	6.4	10	150/300
YT-4842	9x11	200	16.4	17.8	7.7	7.4	10	150/300
YT-0385	10x11	200	16.3	17.6	6.8	7.2	10	100/200
YT-4843	10x12	195	16.6	18.1	7.0	7.7	10	150/300
YT-4844	11x13	215	19.3	20.8	8.4	8.6	10	80/160
YT-0386	12x13	220	19.6	21.5	7.2	7.7	10	60/120
YT-4845	12x14	215	19.4	21.3	7.6	8.1	10	80/160
YT-4846	13x15	230	22.0	23.6	8.5	9.4	10	80/160
YT-4847	13x16	225	21.9	23.8	8.9	8.8	10	80/160
YT-0387	14x15	230	23.6	21.9	8.9	9.1	10	50/100
YT-4848	14x17	240	21.4	25.4	8.5	9.3	10	50/100
YT-0388	16x17	255	24.6	26.4	8.6	9.3	10	30/60
YT-4849	16x18	250	25.2	27.1	8.9	9.4	10	50/100
YT-4850	17x19	265	26.9	28.2	10.0	10.5	5	30/60
YT-0389	18x19	270	27.5	28.8	10.5	10.2	5	25/50
YT-4851	19x21	285	30.1	33.0	11.6	12.7	5	30/60
YT-0390	20x22	290	30.9	33.4	10.5	11.4	5	20/40
YT-0391	21x23	310	31.9	34.4	11.8	12.4	5	20/40
YT-4852	22x24	315	33.6	36.2	12.7	13.0	5	20/40
YT-4853	23x26	320	36.0	40.2	14.1	14.1	5	20/40
YT-0392	24x27	330	36.2	40.6	11.5	13.2	5	20/40
YT-0393	25x28	355	37.8	42.1	13.6	14.8	3	15/30
YT-4854	27x30	350	40.4	43.5	14.7	14.6	5	15/30
YT-0394	30x32	390	44.0	47.1	13.8	14.9	3	15/30

Double open end spanner

8 PCS DIN 3110 CrV S.A.E.



YATO	Ø	L (mm)		
YT-48371	1/4" x 5/16"	120	1800	1
	3/8" x 7/16"	155		
	1/2" x 9/16"	185		
	5/8" x 11/16"	200		
	11/16" x 3/4"	220		
	13/16" x 7/8"	235		
	15/16" x 1"	260		
	1-1/8" x 1-1/4"	295		

Bi-hexagonal ring spanner

8 PCS DIN 838 CrV AS-DRIVE



8x10, 11x13, 12x14, 17x19, 21x23, 22x24 mm

YATO		
YT-48184	1250	6



1

Bi-hexagonal ring spanner set

8 PCS DIN 838 CrV AS-DRIVE



5.5x7,8x10, 9x11, 12x14, 14x17, 17x19, 19x21,24x27 mm

YATO		
YT-48185	1430	6

Bi-hexagonal ring spanner set

11 PCS DIN 838 CrV AS-DRIVE



8x10,10x12,11x13,12x14,14x17, 17x19, 19x21,21x23, 22x24,23x26,24x27 mm

YATO		
YT-48187	2700	6

Bi-hexagonal ring spanner set

8 PCS DIN 838 CrV AS-DRIVE



6x7, 8x9, 10x11, 12x13, 14x15, 16x17, 18x19, 20x22 mm

YATO		
YT-0396	1500	6

Bi-hexagonal ring spanner set

10 PCS DIN 838 CrV AS-DRIVE



5.5x7,8x10, 9x11, 10x12,12x14, 14x17, 17x19, 19x21,24x27,30x32 mm

YATO		
YT-48186	2190	6

Bi-hexagonal ring spanner set

11 PCS DIN 838 CrV AS-DRIVE



6x7,8x9,10x11,12x13,14x15,16x17,18x19,20x22,21x23, 24x27,30x32 mm

YATO		
YT-48188	2700	6

Bi-hexagonal ring spanner set

12 PCS DIN 838 CrV AS-DRIVE



6x7, 8x9, 10x11, 12x13, 14x15, 16x17, 18x19, 20x22, 21x23, 24x27, 25x28, 30x32 mm

YATO		
YT-0398	3600	4

Bi-hexagonal ring spanner set

DIN 838 CrV AS-DRIVE S.A.E.

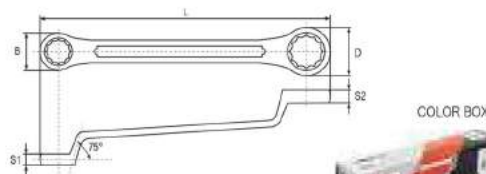

- application: industry
- surface finish: chromed, satin / mirror

YATO	Ø	L (mm)	B (mm)	D (mm)	S1 (mm)	S2 (mm)	PCS packing:	
YT-4860	3/8" x 7/16"	200	16.2	17.5	6.8	6.4	10	150/300
YT-4861	1/2" x 9/16"	235	21.8	23.3	8.4	8.3	10	80/160
YT-4862	11/16" x 3/4"	265	27.0	28.3	10.1	10.0	5	50/100
YT-4863	13/16" x 7/8"	280	30.5	33.3	11.1	11.9	10	20/40
YT-4864	7/8" x 15/16"	305	33.2	35.9	11.8	13.3	5	10
YT-4865	15/16" x 1"	325	35.8	40.0	13.6	13.7	5	10

Bi-hexagonal ring spanner set

6 PCS DIN 838 CrV AS-DRIVE S.A.E.



YATO	Ø	L (mm)		
YT-48651	3/8" x 7/16"	200	1750	1
	1/2" x 9/16"	235		
	11/16" x 3/4"	265		
	13/16" x 7/8"	280		
	7/8" x 15/16"	305		
	15/16" x 1"	325		

Bi-hexagonal ring spanner set

DIN 838 CrV 6140 AS-DRIVE

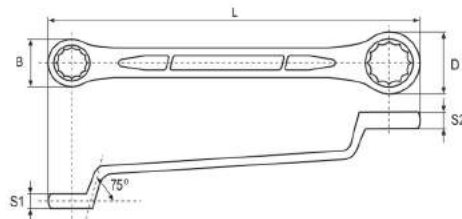

COLOR BOX



- application: industry
- 72 teeth ratchet
- minimum operation angle: 5°
- articulated joint for ring head
- surface finish: chromed, mirror



YATO	Ø (mm)	L (mm)	B (mm)	D (mm)	S1 (mm)	S2 (mm)	PCS packing	
YT-0207	6x7	188	10.4	11.9	5.7	6.2	10	320
YT-0209	8x9	183	13.3	14.8	6.7	7.2	10	160
YT-0211	10x11	198	16.3	17.7	7.7	8.8	10	100
YT-0213	12x13	217	19.2	20.6	8.7	9.2	10	100
YT-0215	14x15	239	22.1	23.4	9.6	10.1	5	50
YT-0217	16x17	260	25.0	26.4	10.6	10.9	5	60
YT-0219	18x19	292	27.9	29.4	11.2	11.5	5	60
YT-0222	20x22	318	30.8	33.7	11.8	12.5	5	30
YT-0223	21x23	326	32.3	35.2	12.1	12.8	5	30
YT-0227	24x27	329	36.6	40.7	13.1	14.0	5	30
YT-0228	25x28	347	38.1	42.5	14.0	14.3	2	16
YT-0232	30x32	362	45.2	49.2	15.0	15.7	2	16

Bi-hexagonal ring spanner

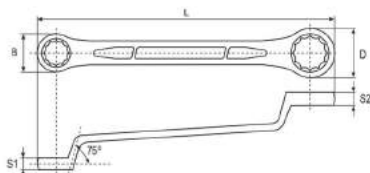

COLOR BOX



- surface finish: chromed, satin

YATO	Ø (mm)	L (mm)	B (mm)	D (mm)	S1 (mm)	S2 (mm)	PCS packing	
YT-02329	34x36	408	46	52	17.5	17.5	5	20
YT-02330	32x36	408	52	46	17.5	17.5	5	20
YT-02331	36x41	448	58	52	18	18	5	20
YT-02332	41x46	483	65	58	18.5	18.5	5	15
YT-02333	46x50	495	71	65	19	19	5	10
YT-02334	50x55	538	78	71	19.5	19.5	5	10

Bi-hexagonal ring spanner set

8 PCS DIN 838 CrV 6140 AS-DRIVE



6x7, 8x9, 10x11, 12x13, 14x15, 16x17, 18x19, 20x22 mm

YATO			
YT-0248	1600	6	

Bi-hexagonal ring spanner set

10 PCS DIN 838 CrV 6140 AS-DRIVE



6x7, 8x9, 10x11, 12x13, 14x15, 16x17, 18x19, 20x22, 21x23, 24x27 mm

YATO			
YT-0250	2600	10	

Bi-hexagonal ring spanner set

12 PCS DIN 838 CrV 6140 AS-DRIVE



6x7, 8x9, 10x11, 12x13, 14x15, 16x17, 18x19, 20x22, 21x23, 24x27, 25x28, 30x32 mm

YATO			
YT-0252	3800	4	

1

Open end swivel head socket wrench

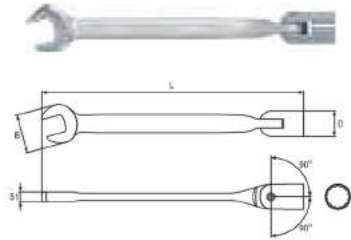

- swivel head:180°
- surface:chromed,satin

YATO	Ø (mm)	L (mm)	B (mm)	D (mm)	S1 (mm)	PCS packing	Box
YT-4950	8	168	19.5	12.9	6.0	10	240
YT-4951	10	178	20.7	14.6	6.4	10	240
YT-4952	11	188	25.4	15.9	6.9	10	200
YT-4953	12	191	25.3	17.9	6.7	10	160
YT-4954	13	205	28.8	18.8	6.8	10	120
YT-4955	14	222	31.8	19.8	6.8	10	80
YT-4956	17	232	37.0	23.9	7.8	10	80
YT-4957	19	248	42.1	25.8	7.5	10	60

Open end swivel head socket wrench set



- swivel head:180°
- surface:chromed,satin

YATO	Ø (mm)	L (mm)	PCS packing	Box
YT-4960	8	170	1	20
	10	180		
	12	195		
	13	210		
	17	235		
	19	255		

Double flexible socket wrench

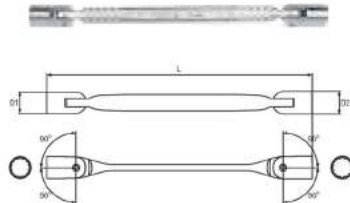

- swivel head:180°
- surface:chromed,satin

YATO	Ø (mm)	L (mm)	D1 (mm)	D2 (mm)	PCS packing	Box
YT-4961	8x9	183	12.9	13.7	10	200
YT-4962	10x11	202	14.6	15.8	10	160
YT-4963	12x13	218	17.6	18.8	10	120
YT-4964	14x15	239	19.8	21.7	10	80
YT-4965	16x17	257	23.8	23.9	10	40
YT-4966	18x19	274	25.8	25.8	10	40

Double flexible socket wrench set



- swivel head:180°
- surface:chromed,satin

YATO	Ø (mm)	L (mm)	PCS packing	Box
YT-4967	8x9	180	1	12
	10x11	200		
	12x13	220		
	14x15	242		
	16x17	254		
	18x19	275		

Single end wrench



YATO	size(mm)	L(mm)	Box
YT-49131	17	170	400
YT-49132	19	170	150
YT-49133	21	213	150
YT-49134	22	213	100
YT-49135	24	213	100
YT-49136	27	213	50
YT-49137	30	235	50
YT-49138	32	265	50
YT-49139	34	265	40
YT-49140	36	300	40
YT-49141	38	300	40
YT-49142	41	332	20
YT-49143	46	360	20
YT-49144	50	385	20
YT-49145	55	385	20
YT-49146	60	440	10
YT-49147	65	440	10
YT-49148	70	465	5

Adjust c-hook/pin spanner



YATO	size(mm)	L(mm)	Box
YT-49470	22-50	165	50
YT-49471	32-75	217	50
YT-49472	50-120	288	25



Ring impact wrench



POLYBAG WITH LABEL

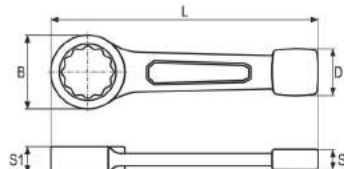

- application: industry
- 12 point profile
- AS-Drive system
- cold forged
- surface finish: black oxidised

YATO	Ø (mm)	L (mm)	B (mm)	D (mm)	S1 (mm)	S2 (mm)	1/2"
YT-1601	24	160	41	31	15.0	10.0	5/25
YT-1602	27	185	47	33	15.0	12.0	5/25
YT-1603	30	190	51	35	16.5	14.0	5/25
YT-1604	32	195	54	37	16.5	15.0	5/25
YT-1605	36	210	60	39	20.0	17.0	5/10
YT-1606	38	210	60	39	20.0	17.0	5/10
YT-1607	41	225	66	42	20.0	18.0	5/10
YT-1608	46	240	74	44	22.0	19.0	5/10
YT-1609	50	250	80	45	23.0	20.0	5/10
YT-1610	55	270	86	55	25.0	22.0	5/10
YT-1611	58	270	86	55	25.0	22.0	5
YT-1612	60	270	92	60	25.0	23.0	5
YT-1613	65	290	100	65	30.0	24.0	5
YT-1614	70	310	108	70	32.0	25.0	5

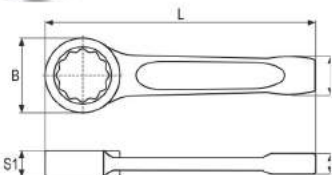

- application: industry
- 12 point profile
- AS-Drive system
- cold forged
- surface finish: black oxidised

YATO	Ø (mm)	L (mm)	B (mm)	D (mm)	S1 (mm)	S2 (mm)	1/2"
YT-3500	75	326	113	62	33.0	18.0	1/10
YT-3501	80	350	124	65	34.0	19.0	1/8
YT-3502	85	355	130	68	36.0	20.0	1/7
YT-3503	90	390	142	72	39.0	23.0	1/5
YT-1624	95	390	142	82	40.0	23.0	1/4
YT-3504	95	390	142	72	39.0	23.0	1/4
YT-3505	100	420	155	78	43.0	25.0	1/5
YT-3506	105	420	155	78	43.0	25.0	1/5
YT-3507	110	450	168	85	45.0	28.0	1/4
YT-3508	115	450	168	85	45.0	28.0	1/4
YT-3509	120	480	182	90	50.0	30.0	1/3
YT-3510	125	480	182	90	50.0	30.0	1/3
YT-3511	130	520	200	95	57.0	31.0	1/2
YT-3512	135	520	200	95	57.0	31.0	1/2
YT-3513	140	520	220	95	57.0	31.0	1/2
YT-3514	145	565	220	104	58.0	32.0	1/2
YT-3515	150	565	220	104	58.0	32.0	1/2
YT-3516	155	565	220	104	58.0	32.0	1/2
YT-3517	160	585	240	113	58.0	33.0	1

Ring impact wrench



POLYBAG WITH LABEL

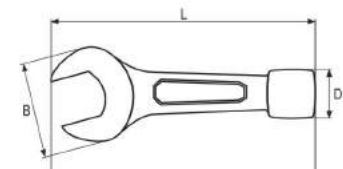

- application: industry
- head offset: 15°
- cold forged
- surface finish: black oxidised

YATO	Ø (mm)	L (mm)	B (mm)	D (mm)	S1 (mm)	S2 (mm)	1/2"
YT-16148	22	163	45	20	7	14	5/50
YT-16149	24	176	51	24	9	14	5/50
YT-1615	27	180	55	33	15	12	5/25
YT-1616	30	187	63	35	17	14	5/25
YT-1617	32	195	67	37	18	15	5/25
YT-1617S	34	208	70	35	18	11	5/10
YT-1618	36	210	77	39	18	17	5/10
YT-16181	38	208	72	35	18	11	5/20
YT-1619	41	225	89	42	20	18	5/10
YT-1620	46	255	98	44	20	19	5/10
YT-1621	50	280	107	45	22	20	5/10
YT-1622	55	310	118	55	25	22	5

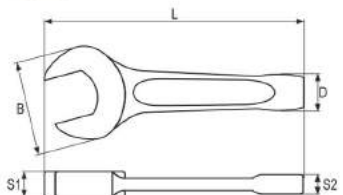

- application: industry
- head offset: 15°
- cold forged
- surface finish: black oxidised

YATO	Ø (mm)	L (mm)	B (mm)	D (mm)	S1 (mm)	S2 (mm)	1/2"
YT-3518	60	315	128	52.0	23.5	15	1/5
YT-3519	65	335	141	59.0	27.5	16	1/8
YT-3520	70	370	156	61.5	28.5	17	1/6
YT-3521	75	375	162	65.0	29.0	18	1/7
YT-3522	80	400	174	72.0	32.0	19	1/5
YT-3523	85	400	174	72.0	32.0	19	1/5
YT-3524	90	445	194	80.0	36.0	20	1/4
YT-3525	95	445	194	80.0	36.0	20	1/4
YT-3526	100	485	228	86.0	43.0	23	1/3
YT-3527	105	485	228	86.0	43.0	23	1/3
YT-3528	110	513	238	95.0	45.0	25	1/2
YT-3529	115	513	238	95.0	45.0	25	1/2
YT-3530	120	530	253	98.0	51.0	27	1/2
YT-3531	125	530	253	98.0	51.0	27	1/2
YT-3532	130	560	268	105.0	53.0	29	1/2
YT-3533	135	560	268	105.0	53.0	29	1/2
YT-3534	140	630	290	120.0	56.0	32	1
YT-3535	145	630	290	120.0	56.0	32	1
YT-3536	150	630	290	120.0	56.0	32	1

1

Flare nut wrench

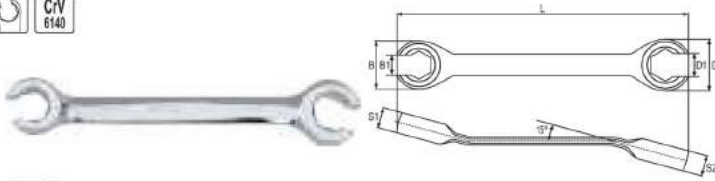

- offset 15°
- surface finish: chromed, mirror



YATO	Ø (mm)	L (mm)	B (mm)	D (mm)	B1 (mm)	D1 (mm)	S1 (mm)	S2 (mm)	PCS packing	
YT-0135	8x10	140	18.7	21.8	6.2	7.2	7.7	8.4	10	200/400
YT-0136	11x12	160	21.2	24.0	8.1	9.2	8.5	9.5	10	100/200
YT-0137	13x14	175	26.3	27.3	9.6	10.7	9.6	10.5	10	100/200
YT-0138	15x17	190	31.2	31.2	11.8	13.0	11.5	10.9	10	50/100
YT-01385	17x19	175	29	31.2	14.5	15	12.8	12.8	10	50/100
YT-0139	19x21	230	36.3	42.1	14.7	16.7	12.4	12.8	10	50/100
YT-0140	22x24	250	42.7	44.2	17.1	18.6	13.2	13.9	10	50/100

Flexible flare nut wrench



- application: industry
- articulated joint at 12 point head
- ring for nuts in sockets
- for use on hydraulic lines
- for use on fuel lines
- for use on brake system lines
- ergonomic handle
- surface finish: chromed, satin

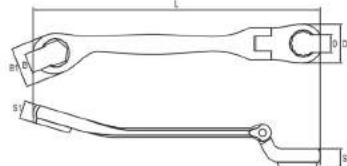

YATO	Ø (mm)	L (mm)	D (mm)	D1 (mm)	S1 (mm)	S2 (mm)	
YT-0180	8	128	6.0	18.0	7.0	7.0	24/288
YT-0181	9	128	6.5	18.0	7.0	7.0	24/288
YT-0182	10	128	7.0	18.0	7.0	7.0	24/288
YT-0183	11	146	8.5	22.0	9.0	9.0	24/216
YT-0184	12	148	9.0	22.0	9.0	9.0	24/216
YT-0185	13	175	10.0	26.0	11.0	11.0	12/120
YT-0186	14	175	11.0	26.0	11.0	11.0	12/120
YT-0187	15	175	12.0	26.0	11.0	11.0	12/120
YT-0188	17	190	14.0	32.0	13.0	13.0	12/96

Heavy duty tubular socket wrench



COLOR BOX



- cold forged body
- surface finish: chromed, Matt
- head: chromed, Polish

YATO	Ø mm	L (mm)	D (mm)	D1 (mm)	D2 (mm)	PCS packing	
YT-4926	30x32	210	13	40	42	5	20

Wrecking bar



YATO	size (mm)	PCS packing	
YT-0807	300x18.5	5	20
YT-0808	400x27	5	20
YT-0809	500x28.5	5	20
YT-0810	600x29	5	20

Ring impact wrench



YATO	size	L (mm)	
YT-15982	1-7/16"	205	25
YT-15983	1-1/2"	205	10
YT-15984	1-5/8"	230	10
YT-15985	2"	255	10

Flare nut wrench set



8x10, 11x12, 13x14, 15x17mm



YATO		
YT-0143	325	25/50

Flexible flare nut wrench set



8, 10, 11, 12, 13, 14, 17 mm

YATO		
YT-0190	425	5/20

L-type socket wrench

CV 6140

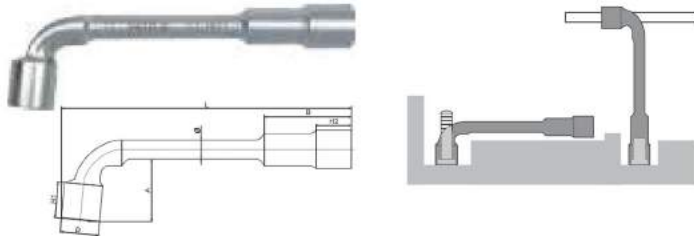

- cold forged body
- L-type wrench with a hole, designed to adapt to additional requirement

YATO	O (mm)	L (mm)	B (mm)	H1 (mm)	H2 (mm)	A (mm)	D (mm)	Ø (mm)	
YT-1626	6	102	25.0	10.0	11.0	16.0	10.0	7	12/60
YT-1627	7	106	27.0	10.2	10.1	21.0	10.7	7	12/60
YT-1628	8	117	29.5	12.3	11.9	18.5	12.2	9	12/60
YT-1629	9	121	31.7	13.4	12.8	19.1	13.2	10	12/60
YT-1630	10	131	35.1	16.4	16.9	23.3	15.0	10	12/60
YT-1631	11	138	36.0	16.5	16.8	24.7	16.3	11	12/60
YT-1632	12	147	42.5	17.9	18.2	17.9	18.0	12	12/60
YT-1633	13	154	44.2	18.5	19.1	30.1	19.3	12	12/60
YT-1634	14	162	47.0	19.3	20.3	30.2	20.8	13	12/60
YT-1635	15	173	48.9	20.6	21.6	31.6	22.3	13	12/60
YT-1636	16	182	55.0	23.2	23.1	37.3	23.6	14	12/60
YT-1637	17	188	57.0	25.1	25.5	37.9	25.1	14	12/36
YT-1638	18	192	57.1	25.1	24.6	40.1	26.0	14	12/36
YT-1639	19	207	62.3	26.9	27.4	41.6	28.2	16	12/36
YT-1640	20	215	62.4	27.0	28.3	42.4	29.2	16	6/24
YT-1641	21	221	65.0	30.5	30.6	54.0	30.2	16	6/24
YT-1642	22	232	67.5	30.8	30.6	49.1	31.7	16	6/24
YT-1643	23	242	77.1	31.4	31.2	51.6	33.0	17	6/18
YT-1644	24	253	78.2	32.3	31.7	53.5	33.6	17	6/18
YT-1645	25	265	81.4	34.3	35.6	55.6	35.4	19	6/18
YT-1646	26	268	77.5	35.3	30.2	57.4	36.8	19	6/12
YT-1647	27	288	85.3	36.9	36.4	54.7	37.6	20	6/12
YT-1648	28	295	87.6	37.8	37.8	60.6	39.2	20	6/12
YT-1649	30	310	95.0	38.4	38.6	65.3	42.0	22	6/12
YT-1650	32	339	99.2	40.4	40.5	66.8	43.8	22	6

Double socket ratchet handle

AS-DRIVE



- cold forged
- surface finish: black phosphated

YATO	size (mm)	L (mm)	PCS packing	
YT-4930	10x12	235	6	10/30
YT-4931	11x13	230	6	10/30
YT-4932	12x14	235	6	10/30
YT-4933	14x17	270	6	8/24
YT-4934	17x19	310	4	20/40
YT-4935	17x21	305	4	20/40
YT-4936	19x21	310	4	20/40
YT-4937	19x22	305	4	20/60
YT-4938	19x24	360	4	20/60
YT-4939	21x26	370	2	2/30
YT-4940	22x24	370	2	2/30
YT-4941	24x27	360	2	2/20
YT-4942	24x30	400	2	2/20
YT-4943	27x32	400	2	2/20
YT-4944	30x32	440	2	2/20
YT-4945S	32x36	445	2	2/20
YT-4946	36x41	447	2	2/20

T-type deep socket wrench with rotary handle

CV 6140

AS-DRIVE



- ergonomic handle
- movable handle with position locking system
- long bar designed for the deeply, narrow working space

YATO	O H (mm)	L1 (mm)	L2 (mm)	Ø (mm)	
YT-1552	8	310	200	10	10/40
YT-1553	9	310	200	10	10/40
YT-1554	10	310	200	10	10/40
YT-1555	11	310	200	10	10/40
YT-1556	12	310	200	10	10/40
YT-1557	13	310	200	10	10/40
YT-1558	14	310	200	10	10/40
YT-1559	15	310	200	10	10/40

T-type adapter with rotary handle

1/4" 3/8" 1/2" CV 6140

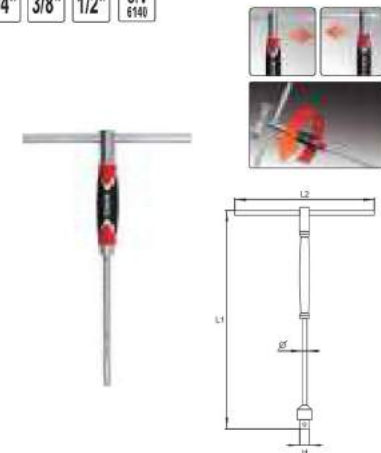

- ergonomic handle
- movable handle with position locking system
- long bar designed for the deeply, narrow working space

YATO	O H	L1 (mm)	L2 (mm)	Ø (mm)	
YT-1565	1/4"	310	200	8	10/40
YT-1566	3/8"	310	200	10	10/40
YT-1567	1/2"	310	200	10	10/40

1

T-type deep socket wrench

C/V
6140 AS-DRIVE

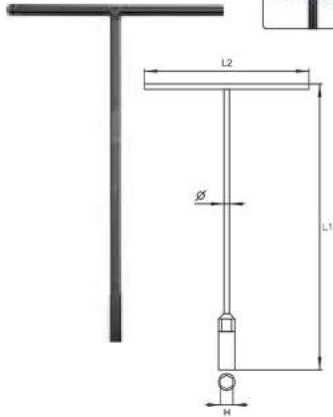

• long bar designed for the deeply, narrow working space

YATO	Ø H(mm)	L1(mm)	L2(mm)	Ø (mm)	
YT-1571	8	310	200	10	10/40
YT-1572	9	310	200	10	10/40
YT-1573	10	310	200	10	10/40
YT-1574	11	310	200	10	10/40
YT-1575	12	310	200	10	10/40
YT-1576	13	310	200	10	10/40
YT-1577	14	310	200	10	10/40
YT-1578	15	310	200	10	10/40
YT-1580	17	310	200	10	10/40
YT-1582	19	310	200	10	10/40

T-type deep socket wrench

C/V
6140 AS-DRIVE



YATO	Ø H(mm)	L (mm)	Ø (mm)	
YT-1583	8-9-10	140	10	10/40
YT-1584	8-10-12	140	10	10/40
YT-1585	9-11-13	140	10	10/40
YT-1586	12-14-17	140	10	10/40

Adjustable wrench

DIN
3117



- dipped handle
- with laserscale
- flexible adjust the open mouth

YATO	L	PCS packing	
YT-21650	6" (150mm)	19	6/36
YT-21651	8" (200mm)	24	6/36
YT-21652	10" (250mm)	30	6/36
YT-21653	12" (300mm)	36	6/24
YT-21654	15" (375mm)	45	2/16

Adjustable wrench

DIN
3117



- with laser scale
- flexible adjust the open mouth

YATO	L	PCS packing	
YT-2071	6" (150mm)	19	6/60
YT-2072	8" (200mm)	25	6/60
YT-2073	10" (250mm)	30	6/36
YT-2074	12" (300mm)	36	6/24
YT-2075	15" (375mm)	46	6/12

Adjustable wrench

DIN
3117 C/V



- with laser scale
- flexible adjust the open mouth

YATO	L	PCS packing	
YT-21649	4" (100mm)	15	6/120
YT-2165	6" (150mm)	20	6/120
YT-2166	8" (200mm)	27	6/60
YT-2167	10" (250mm)	30	6/36
YT-2168	12" (300mm)	34	6/24

Adjustable wrench

DIN
3117



- with laser scale
- flexible adjust the open mouth

YATO	L	PCS packing	
YT-2176	15" (380mm)	43	4/16
YT-2177	18" (460mm)	55	2/12
YT-2178	24" (605mm)	63	6
YT-2179	30" (780mm)	85	4

Adjustable wrench

DIN
3117 C/V



- TPR handle
- with laser scale
- flexible adjust the open mouth

YATO	L	PCS packing	
YT-2170	6" (150mm)	24	6/72
YT-2171	8" (200mm)	30	6/36
YT-2172	10" (250mm)	34	6/48
YT-2173	12" (300mm)	41	6/36

Adjustable wrench

DIN
3117 C/V



- with laser scale
- flexible adjust the open mouth

YATO	L	PCS packing	
YT-21655	6" (150mm)	34	6/72
YT-21656	8" (200mm)	38	6/36
YT-21657	10" (250mm)	50	6/36
YT-21658	12" (300mm)	60	6/24

NEW