



TS2200 Series

TS2200 Tripod Turnstile

TS2211 Tripod Turnstile
(w/ Controller and RFID reader)

TS2222 Tripod Turnstile
(w/ controller and combination fingerprint & RFID reader)

The ZKTeco TS2200 tripod turnstile series is a compact and cost-effective entrance control system designed for high-traffic volume.

TS2200 is a single-lane tripod turnstile series designed for smooth and silent operation and draws very little power. It's made of stainless steel which makes TS2200 highly durable. TS2200 is also surprisingly compact and designed to operate in small workspaces.

TS2200 tripod arms are normally held in a locked position, thus denying access to the secured side. Upon TS2200's reader (RFID and/or fingerprint) positively recognizing a user's valid access card or fingerprint, its tripod arms unlock, thus allowing users passage to the secured side.

Option for built-in REX button allows users to conveniently exit the secured side without needing to use their access card or fingerprint.

During emergencies and power outages the tripod arms completely collapse, thereby ensuring users FAST unencumbered exit to safety.

TS2200 provides both security and convenience, all in a very durable compact design.

Features



Reliability

- Alloy steel tripod hub and SUS304 stainless steel casework & tripod arms ensure long-lasting durability
- Power conservation. Electro-magnetic locks remain in "standby mode" until turnstile is activated
- Patented oil lubrication system reduces need for maintenance
- High quality electrical components



Safety Features

- Tripod-arms unlock & drop during emergencies /power loss
- All smooth finish. No exposed screws or fasteners
- Visual indicator for access granted (or denied)
- Ergonomic design makes card and fingerprint authentication fast & simple for users.
- Secure. Supports Anti-tailgating.



Built-in Reader Integration

- TS2200 series ships already integrated with our customers' preference for either card or fingerprint access control reader. This greatly reduces installation time & expense.
- TS2200 series and associated access control readers are all factory-tested prior to shipping.
- ZKTeco provides true plug'n play turnstiles with the lowest possible total cost of ownership in the industry!



Specifications

Power requirements		AC110V/220V, 50/60Hz
Power Consumption	Starting	82W
	Standby	29W
	Unlock	76W
Working Temperature		-28 °C ~60 °C
Working Humidity		5%~80%
Working Environment		indoor/ Outdoor (if sheltered)
Speed of throughput	RFID	Maximum 32/ minute
	Fingerprint	Maximum 28/ minute
	Face	Maximum 13/ minute
	Vein	Maximum 19/ minute
Lane width(mm)		500
Footprint(mm*mm)		1110*1320
Dimension(mm)		L=1110, W=320, H=980
Dimension with packing(mm)		L=1200, W=440, H=1080
Net weight(kg)		65
Weight with packing(kg)		75
LED indicator		Y
Cabinet material		SUS304 Stainless Steel
Lid material		SUS304 Stainless Steel
Barrier material		SUS304 Stainless Steel
Barrier Movement		Rotating
Emergency mode		Y
Security level		Medium
MCBF		1 million
Options/ Accessories		Counter, SUS316 Cabinet and Lid, Remote Control

Dimensions (mm)

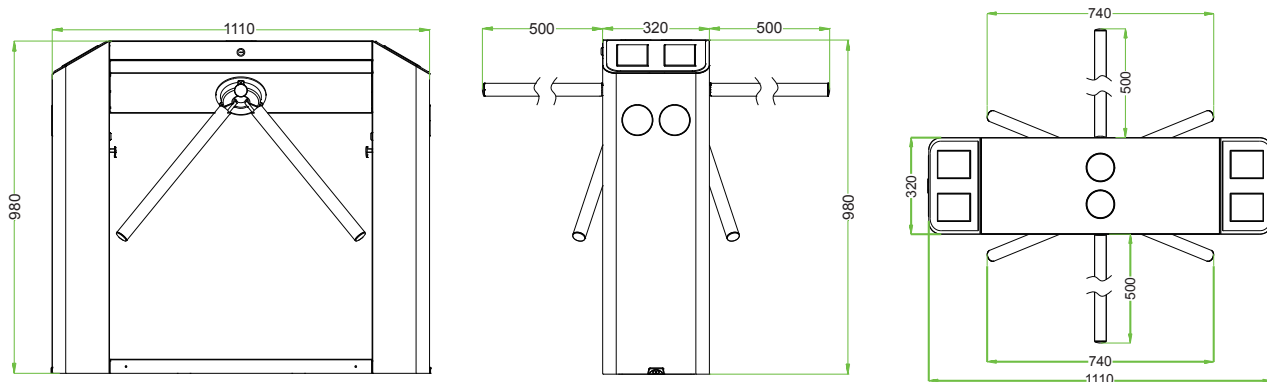

ZKTeco Inc.
www.zkteco.com
 E-mail: sales@zkteco.com

© Copyright 2016. ZKTeco Inc. ZKTeco Logo is a registered trademark of ZKTeco or a related company. All other product and company names mentioned are used for identification purposes only and may be the trademarks of their respective owners. All specifications are subject to change without notice. All rights reserved.

