

## DS-2CE56D8T-VPIT3ZE 2 MP Ultra-Low Light POC Camera

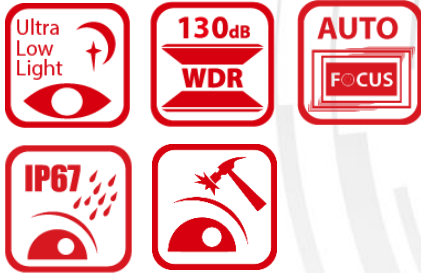

### Key Feature

- 2 MP, 1920 × 1080 resolution
- Ultra-Low Light
- 130 dB true WDR, 3D DNR
- 2.7 mm to 13.5 mm varifocal lens, auto focus
- Smart IR, up to 60 m IR distance
- Power over coaxial
- IP67, IK10



## Specification

<b>Camera</b>	
Image Sensor	2 MP CMOS
Signal System	PAL/NTSC
Frame Rate	PAL: 1080p@25fps NTSC: 1080p@30fps
Resolution	1920 (H) × 1080 (V)
Min. Illumination	0.003 Lux @ (F1.2, AGC ON), 0 Lux with IR
Shutter Time	PAL: 1/25 s to 1/50, 000 s NTSC: 1/30 s to 1/50, 000 s
Slow Shutter	Max. 16 times
Lens	2.7 mm to 13.5 mm motorized, auto focus
Horizontal Field of View	103° to 32.1°
Lens Mount	Φ14
Day & Night	ICR
WDR (Wide Dynamic Range)	≥130 dB
Angle Adjustment	Pan: 0° to 340°, Tilt:0° to 75°, Rotate: 0° to 355°
<b>Menu</b>	
Image Mode	STD/HIGH-SAT
AGC	Yes
Day/Night Mode	Auto/Color/BW (Black and White)
White Balance	Auto/Manual
AE (Auto Exposure) Mode	WDR/BLC/HLC/Global
Privacy Mask	4 programmable privacy masks
Motion Detection	4 programmable motion areas
Noise Reduction	3D DNR
Language	English
Function	Brightness, Sharpness, Mirror, Smart IR
<b>Interface</b>	
Video Output	1 HD analog output
<b>General</b>	
Operating Conditions	-40 °C to 60 °C (-40 °F to 140 °F), humidity: 90% or less (non-condensing)
Power Supply	12 VDC ± 25%/PoC.af
Power Consumption	Max. 7 W
Protection Level	IP67, IK10
Material	Metal
IR Range	Up to 60 m
Communication	HIKVISION-C
Dimensions	Φ 145.2 mm × 124.1 mm (Φ 5.72" × 4.89")
Weight	Approx. 650 g (1.43 lb.)

## Order Model

DS-2CE56D8T-VPIT3ZE

## Dimension

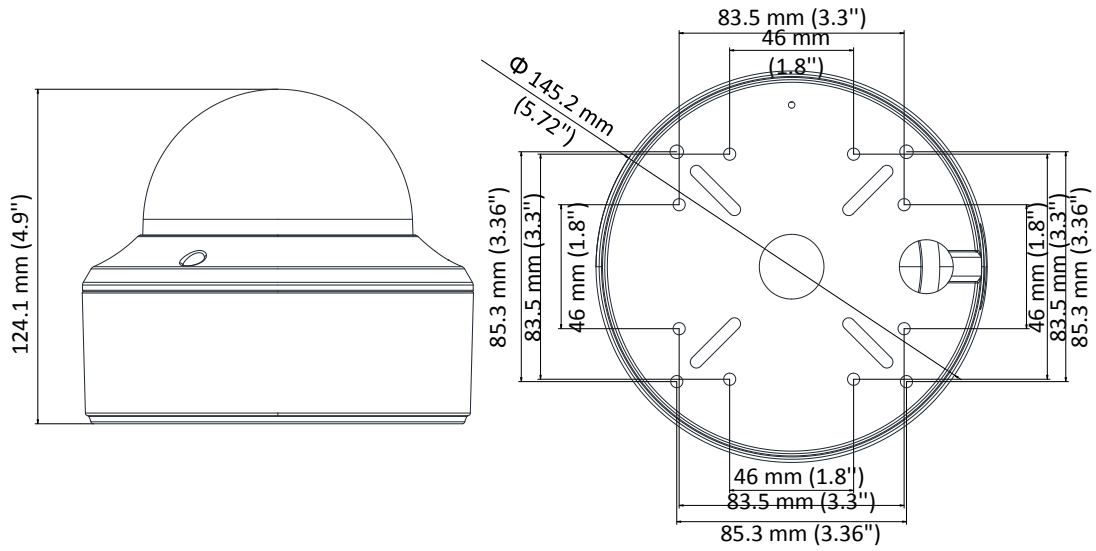

## Accessory



DS-1273ZJ-140  
Wall Mount



DS-1273ZJ-140B  
Wall Mount



DS-1275ZJ-SUS  
Vertical Pole Mount



DS-1276ZJ-SUS  
Corner Mount

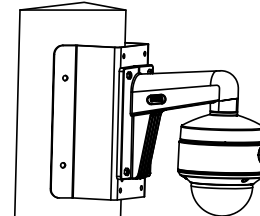
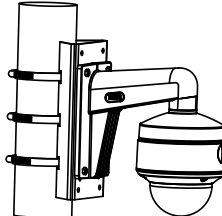
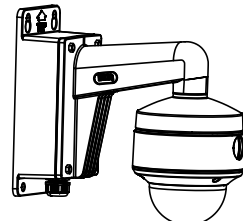
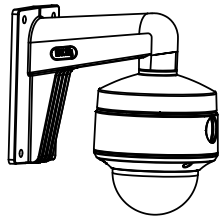

Distributed by

DS-1241ZJ  
In-Ceiling Mount



DS-1240ZJ  
Inclined Ceiling Mount



DS-1253ZJ-L  
Rain Shade

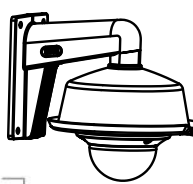
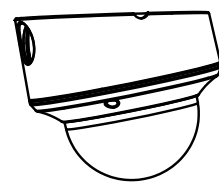
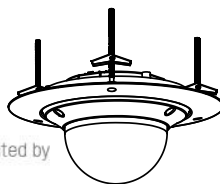

## HIKVISION®

### Headquarters

No.555 Qianmo Road, Binjiang District,  
Hangzhou 310051, China  
T +86-571-8807-5998  
overseasbusiness@hikvision.com

**Hikvision USA**  
T +1-909-895-0400  
sales.usa@hikvision.com

**Hikvision Australia**  
T +61-2-8599-4233  
salesau@hikvision.com

**Hikvision India**  
T +91-22-28469900  
sales@pramahikvision.com

**Hikvision Canada**  
T +1-866-200-6690  
sales.canada@hikvision.com

**Hikvision Thailand**  
T +662-275-9949  
sales.thailand@hikvision.com

**Hikvision Europe**  
T +31-23-5542770  
sales.eu@hikvision.com

**Hikvision Italy**  
T +39-0438-6902  
info.it@hikvision.com

**Hikvision Brazil**  
T +55 11 3318-0050  
Latam.support@hikvision.com

**Hikvision Turkey**  
T +90 [216]521 7070- 7074  
sales.tr@hikvision.com

**Hikvision Malaysia**  
T +601-7652-2413  
sales.my@hikvision.com

**Hikvision UK & Ireland**  
T +01628-902140  
sales.uk@hikvision.com

**Hikvision South Africa**  
Tel: +27 (10) 0351172  
sale.africa@hikvision.com

**Hikvision France**  
T +33(0)1-85-330-450  
info.fr@hikvision.com

**Hikvision Kazakhstan**  
T +7-727-9730667  
nikia.panfilov@hikvision.ru

**Hikvision Vietnam**  
T +84-974270888  
sales.vt@hikvision.com

**Hikvision UAE**  
T +971-4-4432090  
salesme@hikvision.com

**Hikvision Singapore**  
T +65-6684-4718  
sg@hikvision.com

**Hikvision Spain**  
T +34-91-737-16-55  
info.es@hikvision.com

**Hikvision Tashkent**  
T +99-87-1238-9438  
uzb@hikvision.ru

**Hikvision Hong Kong**  
T +852-2151-1761  
info.hk@hikvision.com

**Hikvision Russia**  
T +7-495-669-67-99  
saleru@hikvision.com

**Hikvision Korea**  
T +82-(0)31-731-8817  
sales.korea@hikvision.com

**Hikvision Poland**  
T +48-22-460-01-50  
info.pl@hikvision.com

**Hikvision Indonesia**  
T +62-21-2933759  
Sales.Indonesia@hikvision.com

**Hikvision Colombia**  
sales.colombia@hikvision.com