

Operating Instructions

Portable Metal Hardness Tester Piccolink Software *(only for Piccolo 2)*



U.S. Patent No. 8,074,496

proceq

Table of Contents

Equotip Piccolo 2

Equotip Bambino 2

1. Safety and Liability

1.1. Safety and Usage Precautions	4
1.2. Liability and Warranty	4
1.3. Safety Instructions	4
1.4. Labelling	4

2. Tutorial

2.1. Principle	5
2.2. Sample Preparations	5
2.3. Testing Procedure	5
2.4. Testing light Samples	6
2.5. Testing curved Surfaces	6

3. Overview

3.1. Application Examples	7
3.2. Product Version and Accessories	7
3.3. Device Overview	8
3.4. Function Keys	8
3.5. Basic Settings	9
3.6. Programming Advanced Settings	10

4. Getting Started

4.1. Power on/off	11
4.2. Auto Shutdown	11
4.3. Charging the Battery	11
4.4. Performance Check	12

5. Settings

5.1. Hardness Scales	13
5.2. Material Groups	13
5.3. Compensation of non-vertical Impact Direction	15
5.4. Tensile Strength (<i>Equotip Piccolo 2 only</i>)	15
5.5. Custom Conversion Curves (<i>Equotip Piccolo 2 only</i>)	15

6. Advanced Settings

6.1. Using the DL Accessory Kit	16
6.2. Shore Conversion Standard	16
6.3. Lock Settings (<i>Equotip Piccolo 2 only</i>)	17
6.4. Fixed Number of Impacts (<i>Equotip Piccolo 2 only</i>)	17
6.5. Impact Counters (<i>Equotip Piccolo 2 only</i>)	17

7. Data Evaluation

7.1. Statistics	18
7.2. PC Application Software Piccolink (<i>Equotip Piccolo 2 only</i>)	18

8. Technical Specifications

8.1. General	19
8.2. Standards and Guidelines applied	19

9. Part Numbers and Accessories	20
10. Maintenance and Support	21
10.1. Regular Device Checks	21
10.2. Firmware Update	21
10.3. Cleaning	21
10.4. Storage	21
10.5. Updating the Equotip Piccolo 2 / Bambino 2 Device Firmware	21
11. Troubleshooting	22
11.1. Battery	22
11.2. Empty Display	22
11.3. Reset	22
11.4. Incorrect Measurements or failed Performance Check	23
11.5. Error Messages	23
Piccolink Software (only for Piccolo 2)	24
1. Safety and Liability	24
1.1. Safety and Usage Precautions	24
1.2. Liability and the “Software License Agreement”	24
2. Installing the Piccolink Software	24
2.1. Installing Piccolink	24
2.2. Installing the USB Driver	25
2.3. Establishing Connection between Device and Computer	25
3. Using the Piccolink Software	26
3.1. Application Examples	26
3.2. Launching Piccolink	26
3.3. Editing Data	27
3.4. Deleting Data	27
3.5. Exporting Data	27
3.6. Remote Control	27
3.7. Lock device	28
3.8. Exit Software and Connection	28
4. Device Settings	29
4.1. Impact Counters	29
4.2. Fixed Number of Impacts	29
4.3. Custom Conversion Curves	29
4.4. Shore Conversion Standard	30
4.5. Impact body D / DL	30
5. Troubleshooting	31
5.1. Uninstall default Drivers to install supplied USB Drivers	31
5.2. Disconnection of the Data Connection	31
5.3. Support	31
5.4. System Requirements	31

Equotip Piccolo 2

Equotip Bambino 2

1. Safety and Liability

1.1. Safety and Usage Precautions

This manual contains important information on the safety, use and maintenance of the Equotip Piccolo 2 / Bambino 2. Read through the manual carefully before the first use of the instrument. Keep the manual in a safe place for future reference.

1.2. Liability and Warranty

Proceq's "General Terms and Conditions of Sale and Delivery" apply in all cases. Warranty and liability claims arising from personal injury and damage to property cannot be upheld if they are due to one or more of the following causes:

- Failure to use the instrument in accordance with its designated use as described in this manual.
- Incorrect performance check for operation and maintenance of the instrument and its components.
- Failure to adhere to the sections of the manual dealing with the performance check, operation and maintenance of the instrument and its components.
- Unauthorized structural modifications to the instrument and its components.
- Serious damage resulting from the effects of foreign bodies, accidents, vandalism and force majeure.

All information contained in this documentation is presented in good faith and believed to be correct. Proceq SA makes no warranties and excludes all liability as to the completeness and/or accuracy of the information.

1.3. Safety Instructions

The instrument is not allowed to be operated by children or anyone under the influence of alcohol, drugs or pharmaceutical preparations. Anyone who is not familiar with this manual must be supervised when using the instrument.

1.4. Labelling

The following icons are used in conjunction with all important safety notes used in this manual.



Danger: This symbol indicates a risk of serious or fatal injury in the event that certain rules of behaviour are disregarded



Note:
This symbol indicates important information.

2. Tutorial

2.1. Principle

During measurement with Piccolo 2 / Bambino 2, an impact body with a hard metal ball indenter is launched by spring energy against the sample to be measured, and then rebounds. Before and after the impact, a permanent magnet inside the impact body passes through a coil in which a voltage signal V is induced by the forwards and backwards movement. This induction signal behaves proportionally to the velocities. The ratio of the rebound velocity v_r to the impact velocity v_i multiplied by 1000 yields the hardness value HL (Leeb hardness). HL is a direct measure of the hardness. While HLD refers to testing with the D device version (impact body 27 mm long, flat support ring), HL DL refers to testing with the slim front section of the DL Accessory Kit (impact body 82 mm long, support ring with slim long front section).

2.2. Sample Preparations

Keep the sample free of vibrations during the test. Light and thin parts must be specially fastened (see “Testing light samples”). Ensure that the surface of the work piece is clean, smooth and dry. If required, use appropriate cleaning agents for cleaning, such as acetone or isopropanol (no water!).

- Minimum sample weight
 - With a compact shape 5 kg (11 lbs)
 - On a solid base 2 kg (4.5 lbs)
 - Coupled to solid base 0.1 kg (0.25 lbs)
- Minimum sample thickness
 - Uncoupled 25 mm (1 inch)
 - Coupled 3 mm (1/8 inch)
 - Layer thickness 0.8 mm (1/32 inch)
- Sample surface condition
 - Roughness class ISO N7
 - Maximum roughness depth Rt 10 μm
 - Average roughness depth Ra 2 μm
- Maximum sample hardness 890 HLD (~ 950 HL DL, ~ 955 HV, ~ 68 HRC)

2.3. Testing Procedure

- Select a hardness unit (see section “Settings”).
- Select automatic compensation for impact directions other than vertical down (↓), when testing in HLD / HL DL.
- Press ▷ to select the averaging mode AVE (AVE).
- Conduct testing impacts by cycling through the “1. load – 2. position – 3. trigger” mechanism.
 1. The impact device – when not in contact with the test piece – is held firmly with one hand and the charging tube is depressed with the other hand until contact is felt. The charging tube is allowed to slowly return to the starting position. Alternatively, this loading movement can be performed in position after an impact (before the device is moved to a new position), or on any other location that shall not be tested later on.
 2. Position the support ring on the test piece. Take particular care to wholly seat the ring on the test piece, but not coinciding with a previous test indentation.
 3. To trigger an impact, push the actuation tube in the direction of the housing. After approx. 1 mm (0.04 inch), the impact body is released.
- After the last impact of a series, press the key ▷ repeatedly to display the hardness average and, in case of the Equotip Piccolo 2, further statistics of the measurement.



Note:

If possible, follow the standard practice of rebound hardness testing as described in the national standards DIN 50156-1 (metallic materials) or ASTM A956 (steel, cast steel and cast iron only). If not possible, the user is recommended to carry out at least 3 to 5 impacts at intervals of 3 to 5 mm (0.12 to 0.20 inch) at each measuring location and to use the average of the individual values.



Note:

Do not carry out an impact in an area that has already been deformed by another impact. Also, do not load the device when it is already positioned in the new test location, since the material under the device may be affected through prior stress.

2.4. Testing light Samples

In case samples are lighter than 2 kg or sample sections have unfavourable mass distribution, samples can go into vibration as the impact body hits the test point. This results in unwanted energy absorption and thereby distorts the test result. Therefore, samples below 5 kg should always be supported by solid worktops. If the mass falls below 2 kg but still exceeds 0.1 kg, “coupling” the sample to a larger mass can help to prevent vibrations, where a rigid connection between the sample and a solid support is ensured.

The following requirements must be met for coupling:

- The contact surface of the sample and the surface of the solid support must be level, flat and ground smooth.
- The sample must be at least 3 mm (0.12 inch) thick.

Follow the coupling procedure:

- Apply a thin layer of coupling paste to the contact surface of the sample.
- Press the sample firmly against the support.
- Rub the sample against the support in a circular motion.

Do the impact as usual, where the impact must be carried out vertically to the coupled surface.

2.5. Testing curved Surfaces

The device only works properly when the impact body is precisely at the end of the tube at the moment of impact. When concave or convex surfaces are tested, the impact body either does not entirely leave the test tube or comes out too far. Replace the standard support ring by a specially suited ring to do the testing (see “Accessories” or contact your local Proceq representative).

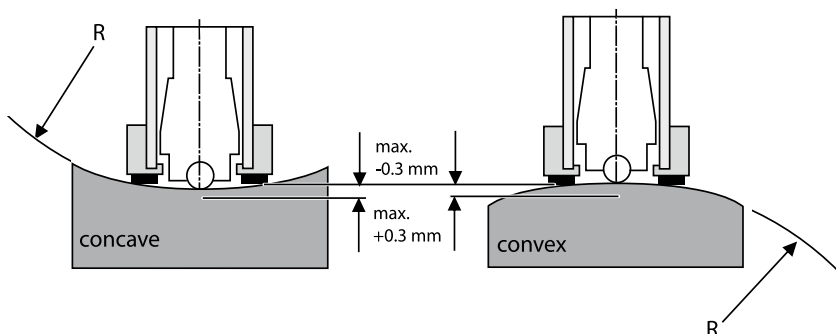

3. Overview

The Equotip Piccolo 2 / Bambino 2 is used for testing the hardness typically of metallic surfaces. The tester measures the Leeb hardness HLD (HLDL with DL Accessory Kit), employing the rebound method. As a result of its compact design, measurements can be carried out quickly, on the spot and in any position and direction. Conversions of the determined HLD or HLDL hardness to different hardness scales are provided to Brinell (HB), Vickers (HV), Rockwell (HRB, HRC) and Shore (HS).

3.1. Application Examples

- Hardness tests on already assembled machines or steel and cast constructions.
- Testing of metallic workpieces when the test indentation should be as small as possible.
- Quality control measurements for quick determination of a particular heat treatment condition.
- Fast testing of numerous measuring points to examine the change of hardness over large areas.
- Automated testing (Piccolo 2 only)



Caution:

Other applications could be dangerous. The manufacturer is not liable for damage caused by improper use or incorrect operation.

3.2. Product Version and Accessories

Equotip Bambino 2

- Instrument with the basic functions

In addition, Equotip Piccolo 2 offers:

- Additional Piccolink PC Software for documented testing incl. statistics
- Testing of special materials using customer-specific hardness conversions
- Conversion to tensile strength for steel (Rm)
- Extended statistics function
- Lock device function to prevent unwanted changes of settings
- Fixed number of impacts where the number of tests per test series can be configured
- (Real-time) Transfer of data to PC or notebook via the USB interface needed in serial production

Equotip Piccolo 2 / Bambino 2 with Equotip DL Accessory Kit only:

- Testing in confined spaces and on recessed surfaces



Note:

The Equotip Piccolo 2 has a dark, the Bambino 2 has a light grey housing bottom.

3.3. Device Overview



- | | |
|----------------|-----------------------|
| 1 USB socket | 7 CANCEL function key |
| 2 USB cover | 8 housing |
| 3 impact body | 9 FEED function key |
| 4 support ring | 10 MENU function key |
| 5 finger grip | 11 guide tube |
| 6 unit display | 12 charging tube |

3.4. Function Keys

Key	Functions
◀ «CANC»	<ul style="list-style-type: none"> Deletes the last impact. Navigates to the previous menu option.
▶ «FEED»	<ul style="list-style-type: none"> Starts / Terminates measurement series. Navigates to the next menu option.
▽ «MENU»	<ul style="list-style-type: none"> Navigates to the next menu level. Confirms selection in resp. menu level.
◀ «CANC» & ▽ «MENU» for at least 2 seconds	<ul style="list-style-type: none"> Enter advanced settings menu

3.6. Programming Advanced Settings

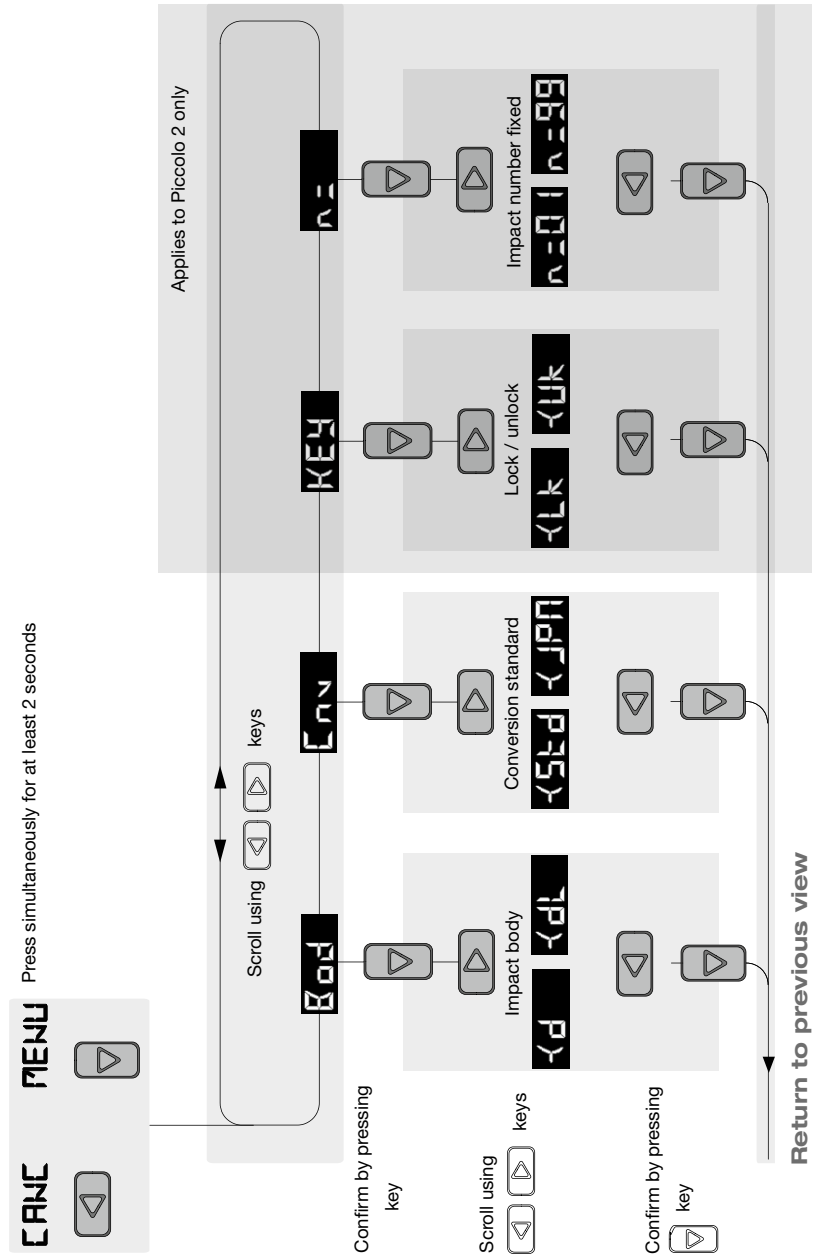

4. Getting Started

4.1. Power on/off

The instrument is always ready for operation. To switch on the Equotip Piccolo 2 / Bambino 2, simply press a key or load the device and trigger an impact, as described in "Testing procedure". The instrument displays the value as shown before shutting down. If the instrument is turned on by performing a new impact, the display shows the new measurement.

4.2. Auto Shutdown

After 5 minutes without activity, the device automatically switches to sleep mode (blank display).



Note:

A reset can be carried out to correct faults, display the serial number and set the device to its default settings. Press all three keys (<, >, ∇) at the same time. The instrument performs a diagnostic self-check. Information about the device will be displayed: product name, serial number, conversion standard and USB connection status.

4.3. Charging the Battery

A fully charged battery is sufficient for at least 20'000 measurements. If the battery is too weak for further measurements, the message **BAL0** will appear alternately with the result of the last measurement.

To recharge the battery, connect the Equotip Piccolo 2 / Bambino 2 USB socket to the USB power supply or to a PC / notebook. The charging status of the battery is indicated by the LED.

- | | |
|----------------------|---|
| Fast flashing | Battery is charging. Voltage state of the battery is not sufficient for another measurement. After a few minutes, the LED goes from fast flashing to slower flashing. |
| Flashing | Battery is charging. |
| LED continuously lit | Battery is fully charged. |

To fully recharge the battery, it is sufficient to charge for up to 2 hours.



Note:

The battery will self-discharge after 3-5 months if the device is not used.



Caution: The integrated Li-Ion battery allows over 500 complete charge / discharge cycles. If the fast flashing LED does not automatically change to slower flashing after a few minutes of charging, the battery life has expired. The battery then must be changed by qualified service personnel only.

4.4. Performance Check

1. Verify that the Equotip test block is supported by a solid worktop to ensure it is immovable and free of vibrations.
2. Peel off the protective sheet, which should be stored for subsequent reuse. Ensure that the testing surface is clean, smooth and dry. If required, use acetone, isopropanol or similar (no water!) to remove any residues of adhesives or dirt.
3. Power on: To turn on the instrument on, press any key or perform a loading movement.
4. Settings: Enter the Conversion Scale menu level (**<HLD**) for impact body D, and (**<HDL**) for impact body DL with slim test tip included in the DL Accessory Kit) by pressing the key ∇ . Press the key ∇ again to enter the Selection menu level of the hardness scale Leeb. Select automatic direction compensation (**L**) using the key \triangleleft or \triangleright . To confirm the selection press the key ∇ . Start the averaging mode (**Ave**) by pressing the key \triangleright .
5. Perform 10 indentations, which ideally shall be evenly distributed across the diameter of the test block.
6. The average setpoint hardness of the block is engraved in the block surface. The measured average shall coincide with the target range.

Congratulations! Your new Equotip Piccolo 2 / Bambino 2 is fully operational and you can now continue with your measurements.



Note:

First time user: Complete the “Tutorial” or watch a demonstration by a qualified Proceq representative.



Note:

Ensure that the testing surface is clean, smooth and dry before you stick the protective sheet back on the test block.



Note:

Please refer to “Advanced Settings” – “Using the DL Accessory Kit” to change the device setup from D to DL probe, and vice versa.

5. Settings

When starting up after reset or battery depletion, the Equotip Piccolo 2 / Bambino 2 is at the Impact menu level and set to the default settings (hardness scale HLD / HLDL with impact direction correction and single readings). To adjust the settings, press the key ▾ to enter the Conversion menu level.



Note:

In case of the Equotip Piccolo 2, regardless of the settings all data are automatically stored as original HLD / HLDL values with impact direction and time. When transferring the data to the PC using the Piccolink software, they can then be converted to any other scale without accumulation of conversion errors, since the stored original HLD / HLDL value is used as the original value for all conversions.

5.1. Hardness Scales

To change hardness scale, proceed as follows:

- Press the key ▾ to enter the Conversion menu level.
- Browse through the hardness scales with the keys ◀ or ▶ until the desired hardness scale appears in the display.
- Press key ▾ to enter the material group selection. To change the hardness scale, a valid material group must be selected (Please refer to section “Material groups”).



Note:

Simply perform an impact to return to the Impact menu level without change of hardness scales.



Note:

To measure in the native rebound scale HLD / HLDL, no material group must be selected, as no conversion is applied. Hardness scale conversions to other scales only apply when the appropriate material group is selected. Suitability of conversions for specific materials should be qualified on calibrated samples before use.

5.2. Material Groups

To change material group proceed as follows:

- Use the keys to choose a hardness scale and enter the Selection menu level (please refer to section “Hardness scales”).
- Browse through the material groups with the keys ◀ or ▶ until the desired material group appears in the display.
- Confirm selection with the key ▾ and return to impact. The hardness scale symbol or the converted last measurement will be displayed.

Equotip Piccolo 2 / Bambino 2 with impact body D:

Material group	HLD HLd	HV HV	HB Hb	HRC HRC	HRB HRB	HS HS	Rm * Rm
1 Steel and cast steel MG 1	150-950 (independent of material group)	81-955	81-654	20-68	38-100	30-100	
Tensile strength σ_1 E 1							271-2193
Tensile strength σ_2 E 2							619-1477
Tensile strength σ_3 E 3							451-846
2 Cold worktool steel MG 2		80-900			21-67		
3 Stainless steel MG 3		85-802	85-655		20-62	47-102	
4 Cast iron lamellar graphite GG MG 4		90-698	90-664		21-59		
5 Cast iron nodular graphite GGG MG 5		96-724	95-687		21-61		
6 Cast aluminium alloys MG 6		22-193	19-164			24-85	
6.1 Alu-AN40 MG6.1				31-176			
7 Copper / zincalloys (brass) MG 7				40-173		14-95	
8 CuAl / CuSnalloys (bronze) MG 8				60-290			
9 Wrought copper alloys, low alloyed MG 9				45-315			

* only Equotip Piccolo 2

Equotip Piccolo 2 / Bambino 2 with impact body DL:

Material group	HLDL HDL	HV HV	HB Hb	HRC HRC	HRB HRB	HS HS	Rm* Rm
1 Steel and cast steel MG 1	250-970 (independent of material group)	80-950	81-646	21-68	37-100	31-97	
Tensile strength σ 1 E 1							271-2193
Tensile strength σ 2 E 2							619-1477
Tensile strength σ 3 E 3							451-846
2 Cold worktool steel MG 2		80-905		21-67			
6 Cast aluminium alloys MG 6		20-187	21-191				

* only Equotip Piccolo 2

5.3. Compensation of non-vertical Impact Direction

The effect from impact directions that deviate from vertically down is always automatically compensated when displaying converted scales (i.e. HV, HB, HRC, HRB, HS, and, for Equotip Piccolo 2, also Rm). When displaying HLD / HLDL, the user can choose for or against automatic compensation:

- Press the key ∇ to enter the Conversion menu level.
- Use the keys \triangleleft or \triangleright to navigate to the hardness scale HLD / HLDL (\triangleleft HLD / \triangleright HLDL).
- Confirm with the key ∇ to change to the Selection menu level.
- Use the keys \triangleleft or \triangleright to select ∇ (automatic impact direction compensation) or ∇ (no impact direction compensation).
- Confirm with the key ∇ to change back to the Impact level.

5.4. Tensile Strength (Equotip Piccolo 2 only)

Measurements for certain steels can be converted to tensile strength according to DIN EN ISO 18265. Follow the same instructions as given in "Hardness scales".

5.5. Custom Conversion Curves (Equotip Piccolo 2 only)

When testing materials for which no generally applicable conversions are available, user specific conversions can be defined using the Piccolink software. These custom conversion curves can be accessed through option \triangleleft HCL in the hardness scale menu, see section "Hardness scales".

Note:
 In order to set up custom conversion curves, please refer to the Piccolink part of this manual.

6. Advanced Settings

Simultaneously press the keys ◀ and ▼ for at least 2 seconds to access the Advanced Settings menu. Use the keys ◀ or ▶ to browse through this menu, and confirm with the key ▼ to enter one of the following setting submenus:

6.1. Using the DL Accessory Kit **[Rod]**

The Equotip Piccolo 2 / Bambino 2 can be used either with impact body D (standard) or with impact body DL (available as accessory), respectively:

- The D front section (impact body 27 mm long) is commonly used for most Leeb rebound testing, often referred to as “universal probe for most applications”.
- The DL slim front section (impact body 82 mm long) is used where its narrow profile allows access to confined spaces and recessed surfaces.



Make sure the correct impact body and support ring are inserted in the device, otherwise the instrument does not display a hardness value. Support ring and impact body can be changed simply by releasing an impact and unscrewing the support ring.

In order to apply the correct impact body, proceed as follows:

- In the Advanced Settings level, browse to **[Rod]** and confirm through ▼.
- Use the keys ◀ or ▶ to choose between impact body D **[d]** (hardness scale HLD **[HLD]**) or DL **[dL]** (hardness scale HLDL **[HdL]**)
- Confirm selection with key ▼. The instrument exits the Advanced Settings level and changes back to the Impact level.



Note:

The setting of impact body (D / DL) can be changed also using Piccolink.



Note:

Changing the impact body brings the instrument back to its default settings (hardness scale HLD / HLDL with impact direction correction and single readings). To adjust settings, please refer to section “Settings”.

6.2. Shore Conversion Standard **[RnV]**

The conversion standard used for conversion to Shore hardness HS can be changed in the Advanced Settings menu. Proceed as follows:

- In the Advanced Settings level, browse to **[RnV]** and confirm with the key ▼.
- Use the keys ◀ or ▶ to choose between default conversion according to ASTM E 140 **[Std]** or Japan conversion according to JIS B 7731 **[JPN]**.
- Confirm selection with key ▼. The instrument exits the Advanced Settings menu level and changes back to the Impact level.



Note:

The Shore conversion standard can also be changed using Piccolink.

6.3. Lock Settings **KEY** (Equotip Piccolo 2 only)

The key ∇ can be locked to deny access to the instrument settings. When key lock is activated and the key ∇ is pressed, **LK** appears. To lock / unlock settings proceed as follows:

- In the Advanced Settings menu, browse to **KEY** and confirm with the key ∇ .
- Use the keys \triangleleft or \triangleleft to choose between lock settings **<LK** or unlock settings **<UK**.
- Confirm selection with key ∇ . The instrument exits the Advanced Settings menu level and changes back to the Impact level.



Note:

The lock / unlock function can also be controlled using Piccolink.

6.4. Fixed Number of Impacts **n =** (Equotip Piccolo 2 only)

In order to end a testing series, commonly the user closes the series using the key \triangleright . However, if a fixed number of impacts, e.g. $n = 5$, is desired for each series, automatic termination of the series after 5 recorded values can be set in the Advanced Settings menu level. To set a fixed number of impacts, proceed as follows:

- In the Advanced Settings level, browse to **n =** and confirm with the key ∇ .
- Use the keys \triangleleft or \triangleright to decrease or increase (range from 1 to 99) the current number set on the instrument (e.g. **n = 05**).
- Set the new fixed number of impacts with key ∇ . The instrument exits the Advanced Settings level and changes back to the Impact level.



Note:

The number of impacts can also be set using Piccolink.

6.5. Impact Counters (Equotip Piccolo 2 only)

The Equotip Piccolo 2 features two independent impact counters:

- The measurement counter can be controlled by the user through Piccolink (see the Piccolink part of this manual). This counter has its value increased with the first measurement of a series n in averaging mode, or with each single measurement when the averaging mode is not used.
- The impact counter cannot be reset. This counter is increased after each impact.



Note:

Whilst the impact counter will mainly be used for reasons of a general overview and maintenance, the measurement counter may be used by the user to identify a testing series at the plant. The number of the last completed series is displayed when cycling through the test statistics.

7. Data Evaluation

7.1. Statistics

Statistics for measurement series of up to 99 impacts can be calculated automatically:

- To enter the averaging mode, press the key \triangleright at the Impact level. **AVE** appears.
- Perform the desired number of impacts.
- To cancel the last reading, press the key \triangleleft while the measurement is shown on the display.
- Press the key \triangleright to close the series. The instrument will display the arithmetic average of the measurement series.
- Press the key \triangleright to cycle through the statistics. Equotip Bambino 2 can only display the average, the number of readings, the hardness scale and the material group.



Note:

The measurement series is automatically completed when $n = 99$ is exceeded. The following measurement is the first value of a new measurement series.

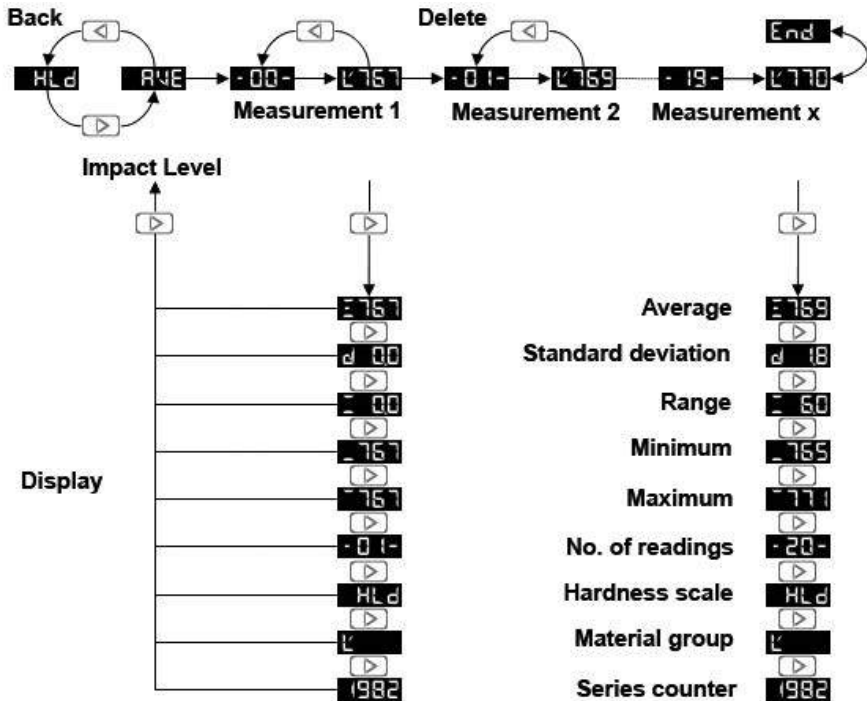

7.2. PC Application Software Piccolink (Equotip Piccolo 2 only)

More Equotip functionality is available through the Piccolink software (see “Piccolink Software”).

8. Technical Specifications

8.1. General

Measuring range	150-950 HLD / 250-970 HLDL
Resolution	1 HLD / HLDL, 1 HV, 1 HB, 0.1 HRC, 0.1 HRB, 0.1 HS, 1 N/mm ² Rm
Measuring accuracy	± 4 HLD / HLDL (0.5 % at 800 HLD / HLDL)
Impact direction	automatic compensation
Impact body	type D / DL
Impact energy	11.5 Nmm / 11.2 Nmm
Velocity of the impact body	2.1 m/s / 1.7m/s
Mass of the impact body	5.5 g (0.2 ounces) / 7.2 g (0.25 ounces)
Diameter of the ball indenter	3.0 mm (0.12 inches) / 2.8 mm (0.11 inches)
Material of the ball indenter	tungsten carbide (approx. 1500 HV)
Maximum test hardness	955 HV
Dimensions	147.5 x 44 x 20 mm (5.71 x 1.75 x 0.79 inches)
Weight	142 g (5 ounces)
Housing	scratch-proof, hard-coated zinc alloy
Display	large high-contrast LCD
Integrated memory	non-volatile, RAM 32 Kbytes
Internal data storage	~ 2,000 measured values
Interface	USB 2.0 (bidirectional)
Battery type	rechargeable Li ion
Charging current	100 mA
Battery operation period	over 20,000 impacts
Operating temperature	-10 to +60°C (14 to 140°F)
Humidity	90 % max
IP classification	IP52

8.2. Standards and Guidelines applied

- ASTM A 956
- ASTM E 140
- ASTM A 370
- ISO 16859
- DIN 50156
- GB/T 17394 JB/T 9378
- ASME CRTD-91
- DGZfP Guideline MC 1
- VDI / VDE Guideline 2616 Paper 1
- Nordtest Technical Reports 424-1, 424-2, 424-3

9. Part Numbers and Accessories

Part No.	Description
352 10 001	Equotip Piccolo 2 Hardness Tester, unit D Equotip Piccolo 2 device with impact body D, small (D6a) and large (D6) support rings, cleaning brush, USB charger and cable, carry case, Proceq neck / wrist strap (lanyard), Equotip CD with Piccolink software and product documentation, operating instructions, product certificate
352 10 002	Equotip Piccolo 2 Hardness Tester, unit D with Proceq test block D Equotip Piccolo 2 device with impact body D, small (D6a) and large (D6) support rings, cleaning brush, USB charger and cable, carry case, Proceq neck / wrist strap (lanyard), Equotip CD with Piccolink software and product documentation, operating instructions, product certificate, Equotip test block D/DC (~775HLD/~630HV) with certificate
352 20 001	Equotip Bambino 2 Hardness Tester, unit D Equotip Bambino 2 device with impact body D, small (D6a) and large (D6) support rings, cleaning brush, USB charger and cable, carry case, Proceq neck / wrist strap (lanyard), Equotip CD with PqUpgrade software and product documentation, operating instructions, product certificate
352 20 002	Equotip Bambino 2 Hardness Tester, unit D with Proceq test block D Equotip Bambino 2 device with impact body D, small (D6a) and large (D6) support rings, cleaning brush, USB charger and cable, carry case, Proceq neck / wrist strap (lanyard), Equotip CD with PqUpgrade software and product documentation, operating instructions, product certificate, Equotip test block D/DC (~775HLD/~630HV) with certificate

352 95 021	Equotip DL Accessory Kit
350 01 015	Equotip coupling paste
357 11 100	Equotip test block D/DC (<500HLD/<225HV)
357 12 100	Equotip test block D/DC (~600HLD/~335HV)
357 13 100	Equotip test block D/DC (~775HLD/~630HV)
357 11 120	Equotip test block DL (<710HLDL/<225HV)
357 12 120	Equotip test block DL (~780HLDL/~335HV)
357 13 120	Equotip test block DL (~890HLDL/~630HV)
357 10 109	Equotip test block add-on calibration D/DC
357 10 129	Equotip test block add-on calibration DL
350 03 000	Set of Equotip support rings (12 pcs.) suitable for D/DC/C/E/D+15
350 03 001	Equotip support ring Z 10-15
350 03 002	Equotip support ring Z 14,5-30
350 03 003	Equotip support ring Z 25-50
350 03 004	Equotip support ring HZ 11-13
350 03 005	Equotip support ring HZ 12,5-17
350 03 006	Equotip support ring HZ 16,5-30
350 03 007	Equotip support ring K 10-15
350 03 008	Equotip support ring K 14,5-30
350 03 009	Equotip support ring HK 11-13
350 03 010	Equotip support ring HK 12,5-17
350 03 011	Equotip support ring HK 16,5-30
350 03 012	Equotip support ring UN

10. Maintenance and Support

Proceq is committed to providing a complete support service for this instrument. It is recommended that the user obtain available updates and other user information regularly.

10.1. Regular Device Checks

Performance checks (see section “performance check”) of the instrument should be carried out at least once a day or at the latest after 1000 impacts. In the case of infrequent use, carry out the check before beginning and at the end of a test series. In addition, have the device calibrated by an authorized Proceq service centre once a year.



Note:

The unit is working properly when the average is within the target range. If the average deviates from the setpoint value by more than ± 6 HLD / HLDL, see section “Troubleshooting”.

10.2. Firmware Update

The device firmware of the Equotip Piccolo 2 / Bambino 2 can be updated using the PqUpgrade PC software.

10.3. Cleaning

- Impact device:
 1. Unscrew the support ring.
 2. Remove the impact body from the guide tube.
 3. Clean the guide tube with the cleaning brush.
 4. Reassemble.
- Ball indenter: Clean the ball indenter of the impact body with acetone, isopropanol or similar.
- Housing: Clean the display with a clean, dry cloth after each use. Clean the USB connector socket with a clean, dry brush.



Note:

Never immerse the device in water or clean it under running water. Do not use abrasives, solvents or lubricants to clean the device.

10.4. Storage

Only store the Equotip Piccolo / Bambino 2 in the original packaging and in a dry room free of dust.

10.5. Updating the Equotip Piccolo 2 / Bambino 2 Device Firmware

Connect the device to the computer. Device firmware upgrades can be done by using either PqUpgrade or Piccolink.

Using PqUpgrade

The computer must be connected to the internet for the update in “Express” mode.

- Launch PqUpgrade.exe” from folder “Equotip Bambino 2\PqUpgrade\” on Equotip CD.
- Select “Express” and confirm with “Next”.

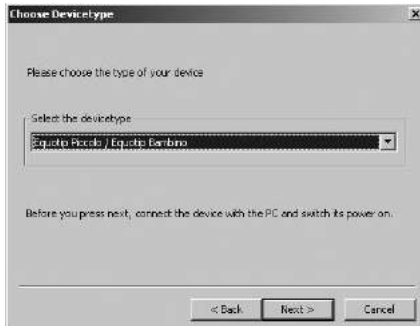
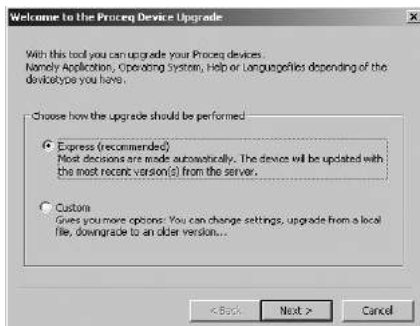

Select the device type and confirm with “Next”.

- In the “Device search result and selection” dialog box, make sure the serial number of the device in the drop-down field is the device to be updated, and then click “Next”.
- PqUpgrade will now search the Proceq servers for any available firmware updates.
- Follow the on-screen instructions to finish the update.

Using Piccolink (*Equotip Piccolo 2 only*)

- Select the “Device” menu from the menu bar and select “PqUpgrade” in the submenu, or click the  symbol in the toolbar.
- Follow the instructions in section “Using PqUpgrade”.



Note:

Before updating the firmware, the measured data should be saved on the computer.



Note:

The “Custom” update is recommended for advanced users only.

11. Troubleshooting

11.1. Battery

-  appears. Charge the battery.
- If the fast flashing LED does not automatically change to slower flashing after a few minutes of charging, the battery must be changed (by qualified service personnel only!).

See section “Charging the battery”.

11.2. Empty Display

If nothing is indicated on the display , activate the device through pressing any key or perform a loading movement or an impact. If nothing happens, the instrument may be too cold and/or the battery may be discharged. Take the device to a warmer place and/or charge the battery.

11.3. Reset

A reset can be carried out to correct faults and to display the serial number. Press all three keys (<1, >, ∇) at the same time. The instrument performs a diagnostic self-check. When the unit has correctly restarted, the following information is displayed in sequence:

- **b00b** and **0888**.
- product name (e.g. PICCOLO 2).
- three-part serial number (e.g. “EP03-001-0001”).
- Japan conversion standard if activated (-J).
- status of the USB connection **0056** (connected) or **005b** (disconnected).
- default hardness scale HLD / HLDL.

11.4. Incorrect Measurements or failed Performance Check

- During the check, if the average deviates from the setpoint value by more than ± 6 HLD / HLDL:
 1. Clean the ball indenter of the impact body. Replace the impact body if necessary, or replace the test block if there is insufficient space for additional tests.
 2. Clean the impact device.
 3. Check the mounting and wear of the support ring. Check for deposits. Clean or replace if necessary.
 4. If the instrument still shows excessive deviations: return the device to an authorized Proceq service centre for recalibration / inspection.
- The incorrect material group, hardness scale or no compensation of impact direction may have been selected. Refer to section “Settings”.
- The selected conversion scale is not in the permissible range (HRC too high **R---**, HRC too low **R---**, or similar). Select another hardness scale.
- Individual values are scattered very widely or are continuously too low.
 1. The testing point is insufficiently prepared. Carefully prepare the testing point for the impact, see section “Sample preparations”.
 2. The impact is triggered while the device is not held vertically on the surface. This may occur especially when using the DL slim front section. Try using the plexiglass sleeve DL for better alignment.
 3. Sample is insufficiently supported. Prepare the sample for the impact e.g. through applying Equotip coupling paste, see section “Testing light samples”.



Note:

Do not re-grind test blocks or try to refurbish impact bodies. This will impair accuracy and may also deteriorate functionality of the Equotip Piccolo 2 / Bambino 2.

11.5. Error Messages

- **Err0** indicates a wrong measurement. Perform an impact in the air. Verify whether the support ring is firmly attached.
- **Err1** indicates a signal failure due to inappropriate environment (e.g. electromagnetic fields). Find an adequate testing environment.
- **Err2**, **Err3**, **Err4** indicate that the impact energy is not within tolerance:
 1. Do not release the impact body too quickly.
 2. Follow the cleaning instructions in section “Maintenance and Support”.
 3. The impact spring may be too weak, damaged or broken. Returned the device for service.
- **Err5**, **Err6**, **Err7** indicate inappropriate application, where the signal cannot be evaluated. The sample may not be seated firmly or may be too light, see “Testing light samples”.

Piccolink Software (only for Piccolo 2)

1. Safety and Liability

1.1. Safety and Usage Precautions

This manual contains important information on the safety, use and maintenance of the Piccolink software. Read through the manual carefully before the first use of the software. Keep the manual in a safe place for future reference.

1.2. Liability and the “Software License Agreement”

Our “General Terms and Conditions of Sale and Delivery” apply in all cases.

All information contained in this documentation is presented in good faith and believed to be correct. Proceq SA makes no warranties and excludes all liability as to the completeness and/or accuracy of the information.

The subject of the license is the software that Proceq dispatches to the customer by electronic means, in the version as sent and in the form as received by the customer. Proceq accepts no responsibility for any properties of the software, either general or in terms of its suitability for any particular purpose. The customer carries the risk that the software may not meet his expectations in terms of results or performance. Proceq shall also not be liable for any damage suffered by the customer or third party irrespective of whether the damage is the direct or indirect consequence of installing or using the software or is in any way connected with installation or use of the software. In particular, Proceq shall not be liable for loss of earnings, profit or savings, or for loss of or damage to software or data. This applies even if Proceq is expressly made aware of such risks. Exclusion of liability applies in particular to all direct, indirect or consequential damage that may arise to the customer because the software fails to function properly or at all for whatever reason.

2. Installing the Piccolink Software

2.1. Installing Piccolink

- Insert the Equotip CD into the computer.
- Launch the “PICCOLINK_Setup.exe” file from the folder ...\Equotip Piccolo 2\ Piccolink Software\ on the CD.
- Follow the on-screen instructions.
- When the dialog box “Completing the Piccolink Setup Wizard” is displayed, make sure the check box “Launch Piccolo 2 USB Driver Install” is selected before you press “Finish”.



2.2. Installing the USB Driver

The USB driver establishes communication between the device and the computer via a USB interface.

- The installation dialog of the USB driver pops up automatically when the software is installed.
- Follow the on-screen instructions.
- When the dialog box “InstallShield Wizard Complete” is displayed, make sure the check box “Launch the CP210x VCP Driver Installer” is selected before you press “Finish”.

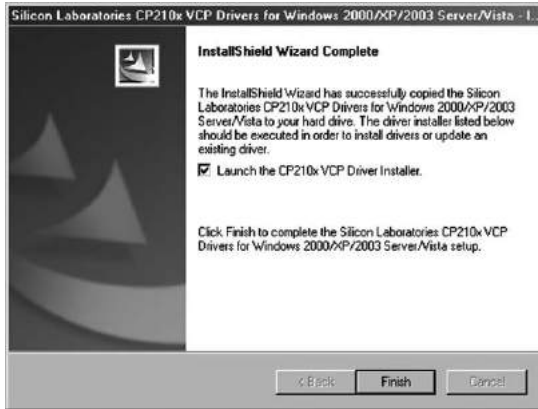

- In the new dialog box press “Install” to install the driver.
- Restart the computer to complete the installation.



Note:

Use Piccolink of version 2.5.1 or later with Equotip Piccolo and Equotip Piccolo 2. Older versions are not compatible with the Equotip Piccolo 2.



Note:

A message may pop-up warning you that the software has not passed the Windows Logo testing. Click “Continue Anyway”.

2.3. Establishing Connection between Device and Computer

- Connect the Equotip Piccolo 2 / Bambino 2 device to the computer using the USB cable.
- The following messages are displayed when the device is first connected to the computer:





Piccolink is now ready to communicate with the device.

3. Using the Piccolink Software

3.1. Application Examples

- Testing of special materials using customer-specific hardness conversions.
- Documented testing incl. statistics.
- Professional evaluation of hardness tests incl. export of data to quality management systems.
- Remotely controlled hardness tests e.g. for automatic measurements during serial production.
- Updating the hardness tester firmware.

3.2. Launching Piccolink

- Start Piccolink using the icon  on the desktop, on the quick launch toolbar or start Piccolink from Start menu. The Piccolink user interface will show up.
- Connect the Piccolo 2 to the computer and click the “Connect”  symbol in the toolbar to connect and transfer the readings



Note: The message  is briefly shown on the unit display when connecting the device to the computer.

Most of the functions like “Save” , “Open”  and “Print”  can be used analogously to the correspondent functions in most other Microsoft Windows applications.

3.3. Editing Data

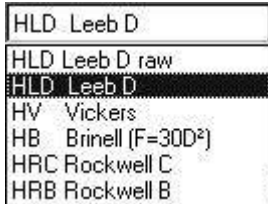

- After selection, single readings or entire measurement series can be edited through the “Edit” menu or right-clicking on the relevant field or row.
- Through the “Edit” menu, the conversion settings for each or all measurement series can be altered. This can also be done using the dropdown menus in columns “Scale” and “Material”.



3.4. Deleting Data

- Select the “Device” menu from the menu bar and select “Delete Device Memory” in the submenu, or click the  symbol in the toolbar.
- Click “Yes” to delete all measurements from the device.
- If you wish to save the measurements to the computer prior to deletion, select “Yes”. If “No” is selected, the device memory is erased irrevocably.

3.5. Exporting Data



Data can be exported by using “Copy”  or “Export” . In both cases, the exported data is a delimited text file, in which the tab character separates each field of the table. The “Copy” function is used to export only the selected fields of the table. It can be pasted directly into an excel sheet.

3.6. Remote Control

Equotip Piccolo 2 devices can be controlled remotely through Piccolink’s Remote Control section.



3.7. Lock device

Use the  /  symbol in the Remote Control section, or access the “Device Settings” dialog through the “Device” menu to lock / unlock the Equotip Piccolo 2 device keys.



Note:

The device can also be (un-)locked using the “Advanced Settings” menu in the Equotip Piccolo 2 device.

3.8. Exit Software and Connection

Quit the software

Select the “File” menu from the menu bar and select “Exit” in the submenu, or click the “Close”  symbol in the right upper corner.

Disconnecting the device

Simply remove the USB cable. The message  is briefly shown on the unit display when disconnecting the device from the computer.

4. Device Settings

The device settings window can be reached by clicking the  symbol in the toolbar. A Piccolo 2 has to be connected. The menu allows reading out and changing some settings of the device. After changes have been made to any of the settings in the dialog box, the actual device settings will be updated only after pressing “Send Settings”.

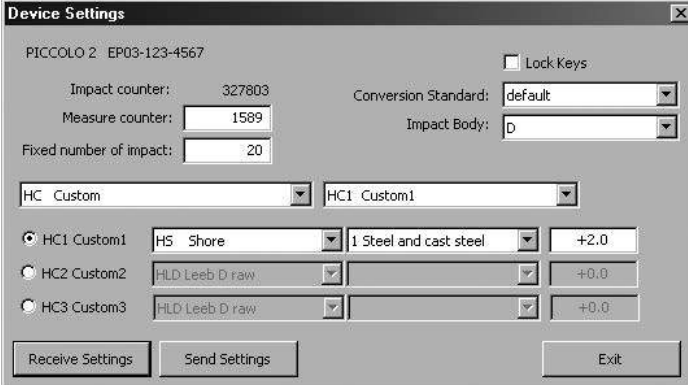

Device Settings

PICCOLO 2 EP03-123-4567 Lock Keys

Impact counter: 327803 Conversion Standard: default

Measure counter: 1589 Impact Body: D

Fixed number of impact: 20

HC Custom HC1 Custom1

HC1 Custom1 H5 Shore 1 Steel and cast steel +2.0

HC2 Custom2 HLD Leeb D raw +0.0

HC3 Custom3 HLD Leeb D raw +0.0

Receive Settings Send Settings Exit



Note:

To update the dialog with the present device settings, click “Receive Settings”.

4.1. Impact Counters

The Equotip Piccolo 2 features two independent impact counters:

- Measurement counter can be controlled by the user through the field “Measurement counter” (range from 1 to 9999).
- Impact counter can only be reset by the device manufacturer.

4.2. Fixed Number of Impacts

In order to automatically complete each measurement series after a pre-defined number n of impacts, use the field “Fixed number of impacts” to adjust n , e.g. $n = 10$.

4.3. Custom Conversion Curves

When testing materials for which no generally applicable conversions are available, the pre-defined standard conversions can be adjusted using the “HC” settings.

When developing such custom conversion curves, the user must pay attention as follows:

- Sample surfaces must be prepared very carefully. If possible, samples shall be of a size which makes coupling to a support base unnecessary.
- The functioning of the Equotip Piccolo 2 device shall be verified against the Equotip test block prior to each measurement series.
- The functioning of the static hardness testing machine (HV, HB, HRC etc.) shall be verified against respective test blocks of the corresponding measuring scale and range.
- To obtain a pair of comparative values, the mean values from at least 10 to 15 HL measurement values and from 3 values from the static test shall be calculated. These values shall be found from proximate positions in a small measuring area.

As an example of a custom conversion curve, see the graphic where the complete conversion curve is parallel-shifted upwards by + 12 HB. This curve can be found when selecting the “HB Brinell” scale and material group “6.1 Alu-AN40 (ABB)”.

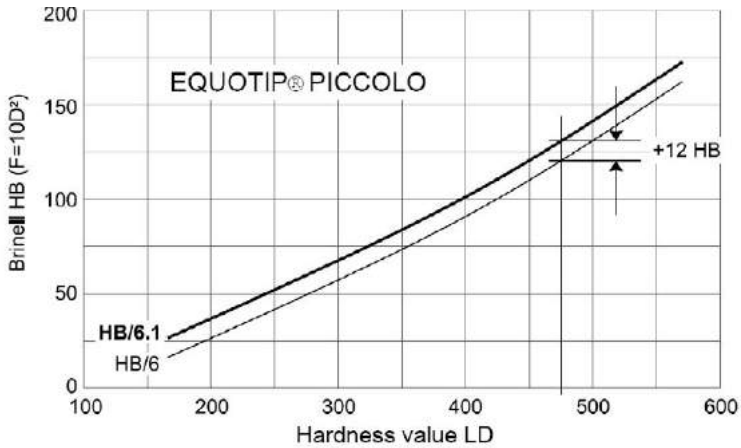

Note:

User-defined conversions can be accessed on the Equotip Piccolo 2 through the option  in the selection menu of the hardness scale, see the device manual.

4.4. Shore Conversion Standard

In order to use Japan Shore conversions according to the JIS B 7731 standard, select “Custom J” from the dropdown field “Conversion Standard”.

4.5. Impact body D / DL

In order to apply the correct device settings after changing the impact body, use the dropdown field “Impact Body”.



Note:

Make sure the correct impact body and support ring are used with the device.

5. Troubleshooting

5.1. Uninstall default Drivers to install supplied USB Drivers

The Piccolink software and the USB driver must be installed before the Equotip Piccolo 2 can be connected to the computer. If the Equotip Piccolo 2 has been connected to the computer before installing the supplied USB driver, default drivers may need to be uninstalled before installing Piccolink:

- Connect device to the computer.
- Open the Windows device manager.
- Locate the Equotip Piccolo 2 (marked as Silicon Labs CP210x USB to UART Bridge) in the device listing.
- Uninstall the Equotip Piccolo 2 (with right mouse click).
- Disconnect the device.

5.2. Disconnection of the Data Connection

- Do not disconnect the unit from the computer during data transfer.
- If the data transfer is interrupted,  is reported.
- Re-establish connection.

5.3. Support

Proceq is committed to providing a complete support service for Piccolink. It is recommended that the user obtain available updates and other user information regularly using Piccolink / PqUpgrade and the Proceq website www.proceq.com.

5.4. System Requirements

- Windows 2000 / Windows XP / Windows VISTA / Windows 7 32/64Bit / Windows 8
- min. 25 MB free disk space
- available USB connector
- CD ROM drive

Proceq Europe

Ringstrasse 2
CH-8603 Schwerzenbach
Phone +41-43-355 38 00
Fax +41-43-355 38 12
info-europe@proceq.com

Proceq UK Ltd.

Bedford i-lab, Priory Business Park
Stannard Way
Bedford MK44 3RZ
United Kingdom
Phone +44-12-3483-4515
info-uk@proceq.com

Proceq USA, Inc.

117 Corporation Drive
Aliquippa, PA 15001
Phone +1-724-512-0330
Fax +1-724-512-0331
info-usa@proceq.com

Proceq Asia Pte Ltd

12 New Industrial Road
#02-02A Morningstar Centre
Singapore 536202
Phone +65-6382-3966
Fax +65-6382-3307
info-asia@proceq.com

Proceq Rus LLC

Ul. Optikov 4
korp. 2, lit. A, Office 410
197374 St. Petersburg
Russia
Phone/Fax + 7 812 448 35 00
info-russia@proceq.com

Proceq Middle East

P. O. Box 8365, SAIF Zone,
Sharjah, United Arab Emirates
Phone +971-6-557-8505
Fax +971-6-557-8606
info-middleeast@proceq.com

Proceq SAO Ltd.

Rua Paes Leme, 136, cj 610
Pinheiros, São Paulo
Brasil Cep. 05424-010
Phone +55 11 3083 38 89
info-southamerica@proceq.com

Proceq China

Unit B, 19th Floor
Five Continent International Mansion, No. 807
Zhao Jia Bang Road
Shanghai 200032
Phone +86 21-63177479
Fax +86 21 63175015
info-china@proceq.com

www.proceq.com

Subject to change without notice.

Copyright © 2017 by Proceq SA, Schwerzenbach
Part number: 82035201E

The Proceq logo consists of the word "proceq" in a bold, lowercase, sans-serif font. The letters are a vibrant teal color. The 'p' and 'q' have a distinctive shape, with the 'q' having a small tail that curves upwards.