

DS-2TP23-10VM/W Handheld Thermography Camera



The handheld thermography camera, specially designed for temperature measurement in transformer substation. It's equipped with a 384×288 resolution thermal detector and a 5MP resolution optical light detector. The 3.5-inch touch screen displays picture in picture of optical and thermal view, fusion of both channels. It helps the staff to quickly find the fault according to accurate temperature measurement of high temperature targets in the environment. Meanwhile it provides assistant decision and ensure safety.

Key Features

- 384 × 288 resolution (thermal), and 1080P resolution (optical)
- DDE (Digital Detail Enhancement) technique
- 3D DNR, adaptive AGC (Automatic Gain Control)
- 640×480 resolution 3.5" LCD touch display
- Built-in rechargeable Li-ion battery
- Up to four hours continuous running



Application Scenarios

The device is mainly applied to various industries, such as Power, Photovoltaic, Metallurgy, Piping, Building, Electronics, Telecommunication, Fire control, and Data center, etc.,



Power



Photovoltaic



Metallurgy



Piping



Building



Electronics



Telecommunication



Fire Control



Data Center

Functions

Thermography

Device detects the real-time temperature, and display it on the screen.

Storage

Device is equipped with built-in memory module to store recorded videos, captured snapshots, and important data.

Fusion

Device can display fusion of thermal view and optical view.

Palette and Alarm

Device supports multiple palettes, and you can set the palette mode according to the alarm function

Wi-Fi Function

Device can be connected to Wi-Fi. You can connect the device via Wi-Fi hot spot, and you can view live view, capture, and recording, etc.

Digital Zoom

Device supports 1×, 2× and 4× digital zoom.

LED Light:

LED light supplement makes the device a torch in required scenarios.

Laser Light Supplement:

Long-distance laser light supplement to point the thermography target.

Specifications

Parameter		Model	DS-2TP23-10VM/W
			Handheld Thermography Camera
Thermal Module	Image sensor		Uncooled Focal Plane Arrays
	Max. Resolution		25Hz: 384 × 288
	Pixel Pitch		17μm
	Response waveband		8μm to 14μm
	NETD		< 40mk (@ 25 °C, F#=1.0)
	Field of View		37.5 ° × 28.5 °
	Focal length		10 mm (Manual focus)
	IFOV (mrad)		1.7mrad
Optical Module	Aperture		F 1.0
	Max. Resolution		1920 × 1080
	Picture Resolution		Display: 384*288; Capture: 1920 × 1080
Image Display	Video Resolution		Display: 384*288; Record:1920 × 1080
	Monitor		640 × 480 resolution 3.5'' LCD touch display
	Palettes		Black hot, White hot, Red hot, Rainbow, Ironbow, Fusion, Rain
	Digital Zoom		Thermal: 1×, 2×, 4×
	Thermal / Optical		Thermal/Optical/Fusion image/Picture in picture
	Picture in Picture		Support Thermal View in Optical View
	Fusion		Support (Thermal View and Optical View Combined)
Thermography	Record Video		Support on-board video recording
	Rules		Max. Temperature; Min. Temperature; Center Temperature; Custom Point/Line/Area Thermometry
	Thermometry Range		-20 °C to 550 °C (-4 °F to 1022 °F)
Battery	Thermometry Accuracy		Max (±2 °C, ±2%)
	Battery Type		dismountable and rechargeable Li-ion Battery
Functions	Battery Operating Time		Four hours continuous running
	Laser Light		Support (Point to the thermography target)
	Storage		Built-in memory module (64G)
	Photo		Thermal/Optical/Fusion image
	Video		Thermal/Optical/Fusion image
	Lighting		Support
	Wi-Fi		Support
	Text Comment		Support
	Voice Comment		Support
General	Language		English
	Power		12 V DC/1.5A, 5V DC/2A (Charging via USB)
	Power Consumption		Approx. 5 W (Wi-Fi On), 4.2 W (Wi-Fi Off)
	Hardware Interface		micro USB
	Working Temperature		-20 °C to 50 °C (-4 °F to 122 °F)
	Protection level		IP54
	Drop Test Height		2 m (6.56 feet)
	Dimension		244 mm × 100 mm × 104 mm (9.6 " × 3.9 " × 4.1 ")
Weight		Approx. 660 g (1.46 lb)	

Order Models

DS-2TP23-10VM/W

Box Content

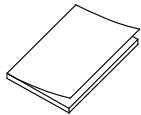

User Manual (x1)

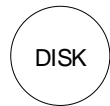

Disk (x1)

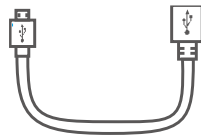

USB Cable (x1)



power Adapter
(x1)

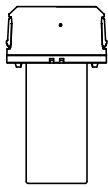

Battery (x1)

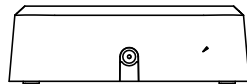

Charging Base (x1)

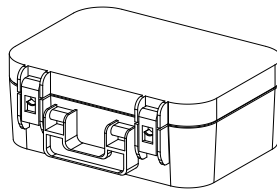

Box (x1)

Dimensions

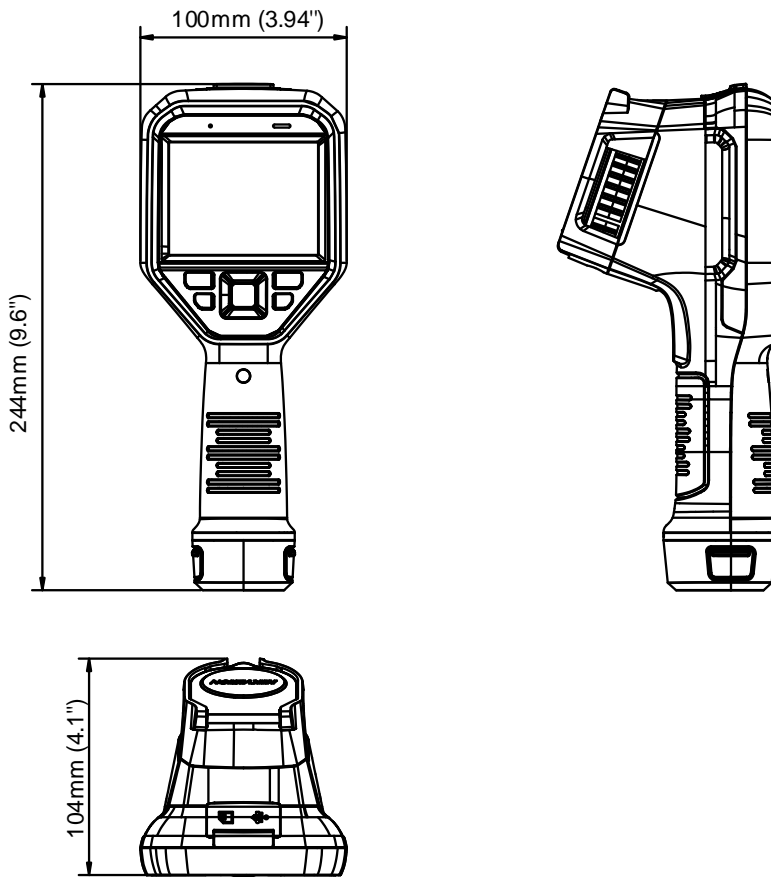

Distributed by



HIKVISION®

Headquarters

No.555 Dianmo Road, Binjiang District,
Hangzhou 310051, China
T +86-571-8807-5998
overseasbusiness@hikvision.com

Hikvision USA
T +1-909-895-0400
sales.usa@hikvision.com

Hikvision Italy
T +39-0438-6902
info.it@hikvision.com

Hikvision Singapore
T +65-6684-4718
sg@hikvision.com

Hikvision Africa
T +27 (10) 0351172
sale.africa@hikvision.com

Hikvision Europe
T +31-23-55-42-770
info.eu@hikvision.com

Hikvision France
T +33(0)1-85-330-450
info.fr@hikvision.com

Hikvision Oceania
T +61-2-8599-4233
salesau@hikvision.com

Hikvision Hong Kong
T +852-2151-1761

Hikvision Middle East
T +971-4-8816086
salesme@hikvision.com

Hikvision Spain
T +34-91-737-16-55
info.es@hikvision.com

Hikvision Canada
T +1-909-895-0400
sales.usa@hikvision.com

Hikvision Russia
T +7-495-669-67-99
saleru@hikvision.com

Hikvision Poland
T +48-22-460-01-50
poland@hikvision.com

Hikvision Korea
T +82-31-731-8841
sales.korea@hikvision.com

Hikvision India
T +91-22-28469900
sales@pramahikvision.com

Hikvision UK
T +01628-902140
support.uk@hikvision.com

Hikvision Brazil
T +55 11 3318-0050
Latam.support@hikvision.com