

EC700 Benchtop Conductivity Meter

Instruction Manual



CE **ISO 9001:2008**

APER A INSTRUMENTS, LLC

www.aperainst.com

Table of Contents

1	Brief Introduction	- 1 -
1.1	Main Features	- 1 -
2	Technical Specifications.....	- 1 -
3	Instrument Description	- 2 -
3.1	LCD Display	- 2 -
3.2	Keypad.....	- 3 -
3.3	Connectors.....	- 4 -
3.4	Stable reading display mode	- 4 -
3.5	Data storage, recall, and deletion	- 4 -
3.6	Max/Min Function	- 5 -
4	Conductivity Measurement.....	- 5 -
4.1	Preparation	- 5 -
4.2	Conductivity Electrode Information.....	- 5 -
4.3	Information regarding Calibration	- 5 -
4.4	Conductivity Calibration (take 1413 μ S as an example).....	- 6 -
4.5	TDS and Conductivity	- 7 -
4.6	Sample Test.....	- 7 -
4.7	Parameter Setting	- 8 -
4.8	Conductivity Electrode's Maintenance.....	- 9 -
5	Complete Kit.....	- 10 -
6	Warranty	- 10 -

1 Brief Introduction

Thank you for purchasing Apera Instruments EC700 Benchtop Conductivity Meter.

This instrument is an outstanding combination of advanced electronics design and sensor technology. It's the most economical choice of a reliable lab benchtop conductivity meter.

Please read this manual carefully to properly use and maintain the meter. Apera Instruments reserves the right to update the contents of this manual without giving prior notices.

1.1 Main Features

- The meter has a built-in microprocessor chip, which enables intelligent functions such as automatic calibration, automatic temperature compensation, data storage, parameter setup, max/min reading display, etc.
- The advanced automatic calibration mode has calibration guide and self-diagnosis functions, automatically recognizing standard calibration solutions.
- The advanced digital processing technology intelligently improves the meter's response time and measuring accuracy with stable reading display mode available.
- The kit comes with a combination conductivity electrode with temperature sensor, measuring conductivity and temperature simultaneously, and allows for automatic temperature compensation.
- IP54 dustproof and spillproof. Connectors are protected by silicone seal caps, effectively ensuring the reliability and service life of the meter under harsh environment.
- Detachable electrode holder and 3 bottles of conductivity calibration solutions come with the kit for convenient use.

2 Technical Specifications

Conductivity	Range	Conductivity: 0-200.0 mS/cm, divided into 4 ranges: (0-199.99) μ S/cm, (200-1999) μ S/cm, (2.00-19.99) mS/cm, (20.0-199.9) mS/cm TDS: (0-100) g/L, divided into 4 ranges: (0-99.9) mg/L, (100-999) mg/L, (1.00-9.99) g/L, (10.0-100.0) g/L
	Resolution	Conductivity: 0.1/1 μ S/cm; 0.01/0.1 mS/cm TDS: 0.1/1 mg/L, 0.01/0.1 g/L
	Accuracy	\pm 1.0% F.S \pm 1 digit
	Temperature Compensation	0 to 50 °C (Auto or Manual)
	Electrode Constant	0.1/1/10 cm^{-1}
	Reference Temperature	25 °C
	Temperature Compensation Coefficient	0.00-9.99%/ °C, default value: 2.00%/ °C

	Calibration	1-4 point Auto Calibration
Temp.	Range	0 to 100°C; 32 to 212°F
	Resolution	0.1°C; 0.1/1°F
	Accuracy	±0.5°C ±1 digit
Others	Data Storage	50 groups
	Storage Content	Numberings, Measurement, Unit, Temperature, Temperature Compensation Status
	Power	DC9V/300mA
	IP Ratings	IP54 dustproof and spillproof
	Size and Dimension	(240*235*103) mm/1kg

3 Instrument Description

3.1 LCD Display

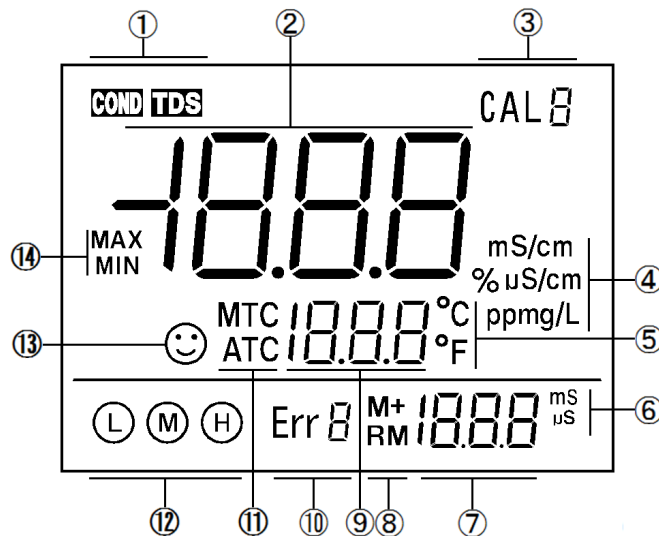

Figure-1

- (1) — Measurement mode
- (2) — Measurement value
- (3) — Calibration icons and numberings
- (4) — Measurement unit
- (5) — Temperature unit
- (6) — The unit displayed during calibration
- (7) — The value displayed during calibration, numberings for storage and recall, and reminder icons
- (8) — Icons for data storage and recall — M+: store measuring data; RM: Recall measuring data
- (9) — Temperature and reminder icons

(10) — Self-Diagnosis icons and numberings

(11) — Temperature compensation mode icons — ATC: Auto Temperature Compensation; MTC: Manual Temperature Compensation

(12) — Completed calibration icons

(13) — Stable reading icon

(14) — Icons for maximum and minimum values

3.2 Keypad

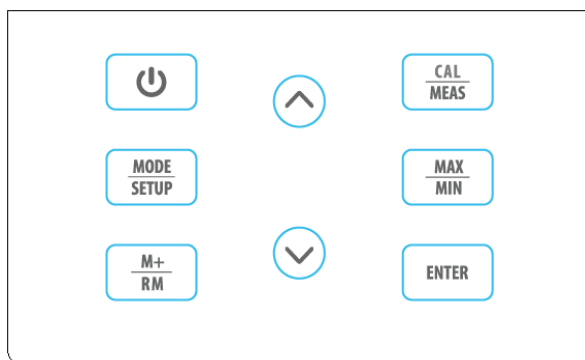

Figure-2

3.2.1. Keypad operations

Short press ----- <1.5 seconds; Long press ----- >1.5 seconds.

3.2.2 For keypad operation, please see Table-1.

Table – 1 Keypad operations and descriptions

Keypad	Operation	Functions
	Short Press	<ul style="list-style-type: none"> ● Power on/off
	Short Press	<ul style="list-style-type: none"> ● Select measuring mode: Cond→TDS.
	Long Press	<ul style="list-style-type: none"> ● Enter parameter setting : P1→P2→...P6.
	Short Press	<ul style="list-style-type: none"> ● Enter Calibration mode ● Cancel any operation and go back to measurement mode
	Short Press	<ul style="list-style-type: none"> ● In calibration mode, press to conduct calibration ● In parameter setting, press to confirm selection
	Short Press	<ul style="list-style-type: none"> ● Store measuring data
	Long Press	<ul style="list-style-type: none"> ● Recall stored measuring data
 	Short Press or Long Press	<ol style="list-style-type: none"> 1. In manual temperature compensation mode, short press to change temperature, long press to change quickly 2. In parameter setting mode, short press to change parameter and settings. 3. In recall mode, short press to change numberings, long press to change quickly.
		Short Press

3.3 Connectors

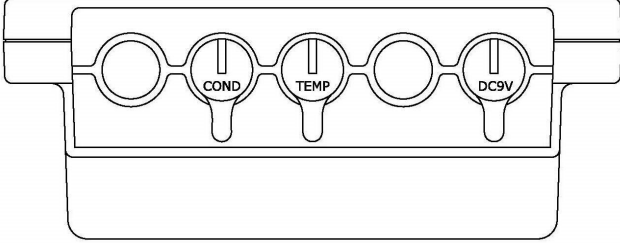

Symbol	Connector Name	Connector Type
COND	Socket for conductivity electrode	BNC
TEMP	Socket for temperature sensor	RCA
DC9V	DC9V power socket	Φ2.5 direct type

3.4 Stable reading display mode

When the measuring value is stable, smiley face icon ☺ appears on LCD, see Figure-3. Please do not get the reading value or make calibration until the ☺ icon appears and stays.

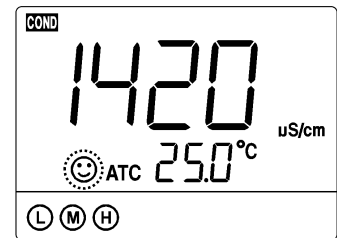



Figure - 3

3.5 Data storage, recall, and deletion

3.5.1 Storage

When the measurement is stable, press  key, the meter displays **M+** icon and storage numberings on LCD, and stores the measuring data. In Figure-4, the meter stores the first group of the measuring data. Press  again to keep storing.

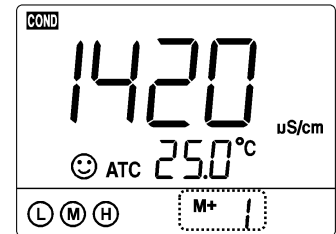







Figure - 4

3.5.2 Recall stored data

In the measurement mode, long press  key to recall the last stored Measuring data. The meter displays **RM** icon and storage numberings. In Figure-5, the meter is recalling the 28th stored measuring data. Keep pressing  and  to recall successively the stored measuring data. Press and hold  and  to quickly recall the stored measuring data. Short press  to go back to measurement mode.

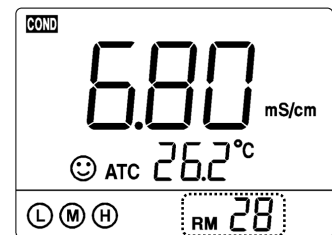



Figure - 5

3.5.3 Clear stored data

The meter can store 50 groups of data. Once the storage is full, if user presses  again, the **FUL** icon will be displayed on LCD (see Figure-6). The storage needs to be cleared in parameter setting P4 so as to keep storing data. The numberings in **M+** indicates the total number of stored data; The

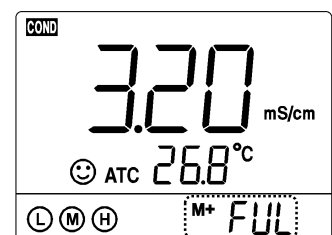





Figure - 6

numberings in RM indicates the number of stored data in current mode (cond/TDS). For example, if 20 groups of data is stored in conductivity mode, and 10 groups in TDS mode, then the numberings for M+ will be “M+30” in both conductivity and TDS mode; the numberings for RM in conductivity mode would be “RM20”, in TDS mode “RM10”.

3.6 Max/Min Function

Use this function to display the maximum or minimum records out of groups of measuring data. In measurement mode, press , LCD will display flashing icons of “MAX/MIN”, indicating the meter has entered the mode of recording maximum and minimum data. After testing, press  again, LCD will alternately display the maximum and minimum value in the past measurements. Press  to go back to regular measurement mode.

4 Conductivity Measurement

4.1 Preparation

4.1.1 Install the electrode holder

The electrode holder is composed of a metal stand base, a supporting pole, and an electrode clip. First, install the metal stand base to the meter (screw it on). Please note that the metal base can be installed on either side of the meter. Then install the supporting pole on the metal stand base, and then install the electrode clip on the supporting pole.

4.1.2 Connect the power adapter

Plug the power adapter tightly into the DC9V socket. The power's voltage should meet the requirements listed on the power adapter.

4.2 Conductivity Electrode Information

4.2.1 Conductivity Electrode

The meter comes with the 2301T-F combination conductivity electrode (K=1.0) with built-in temperature sensor, which enables the automatic temperature compensation. The electrode's housing adopts polycarbonate materials, which is resistant to shocks and corrosion.

4.2.2 Electrode Connectors

The pH electrode has two connectors: the BNC connector connects the conductivity sensor, the RCA connector connects the temperature sensor. Plug these two connectors into “COND” and “TEMP” sockets. Please note do not pull the cables in case of poor contact. Please keep the connectors clean and dry. Refer to section 6.7 regarding how to properly maintain the pH electrode.

4.2.3 Use the Electrode

Stir the electrode for a few seconds after it's dipped into the solution and then let it stand still such that the bubbles inside the probe can be removed and a stable measurement can be quickly obtained.

4.3 Information regarding Calibration

4.3.1 Conductivity standard solutions

The meter automatically recognizes calibration solutions. 1 point or multi-points calibration (up to 4 points) can be adopted. The calibration icons stand for 4 different calibration points ( stands for two standard solutions), see Table-2:

Table-2

Calibration icon		pH standard buffer series
4-Point calibration	(L)	84 μ S/cm
	(M)	1413 μ S/cm
	(H)	12.88 mS/cm
		111.8 mS/cm

4.3.2 How often to calibrate

- We recommend to calibrate the conductivity meter once per month under normal conditions.
- If the requirement for accuracy is high or the temperature of the test sample has a big difference to the reference temperature (25 °C), we recommend to do the calibration once a week.
- Users can tell if the meter needs a calibration by testing the standard calibration solutions. If the measurements you get have a big difference to the standard value of the calibration solutions, then a calibration is necessary.
- For new electrodes or the meter that has been restored to factory default setting, we recommend to conduct 3-4 points calibration. For general uses, users can choose the calibration solutions that are close to the test samples to conduct 1 or 2 points calibration.

4.4 Conductivity Calibration (take 1413 μ S as an example)

4.4.1. Rinse the electrode in distilled or pure water, allow it to dry, wash with a little of standard solution and submerge it in standard solution. Stir the solution briefly and allow it to stay in the solution until a stable reading is reached.

4.4.2. Press **CAL MEAS** key to enter the calibration mode. The “CAL” icon will flash at the top right, and the scanning and locking process of calibration solution will appear at the bottom right.

4.4.3. When the meter locks 1413 μ S, stable icon ☺ will display on LCD. Press **ENTER** key to complete calibration. “End” icon will show up and the meter will return to measuring mode and (M) will show up on the bottom left (see Figure-7).

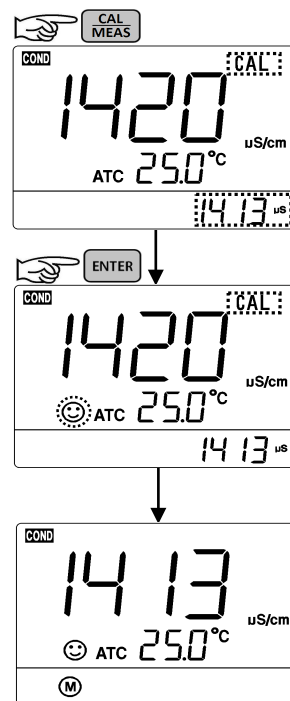

Figure-7

Note: pressing **ENTER** before the reading being stable (☺ shows up and stays), the **Err4** self-diagnosis icon will appear (see section 6.5.2).

4.4.4. For multi-point calibration, please repeat clause 4.3.1-4.3.2 until all the calibration is done. The meter can repeat calibration in the same calibration solution until the stable value is reached.

4.5 TDS and Conductivity

4.5.1. TDS and conductivity is linear related. The conversion factor is 0.40-1.00. Adjust the factor from parameter P2.6. The factory default setting is 0.71 and please refer to Section 7.4. The meter only needs to be calibrated in Conductivity mode, then after calibration of conductivity, the meter can switch from conductivity to TDS.

4.5.2. Adjust TDS conversion factor in parameter setting P4 according to the data collected during testing and experience. Table – 10 lists some commonly used Conductivity and TDS conversion factors. This is for your reference only.

Table – 10 Conductivity and TDS conversion factors



Conductivity of solution	TDS conversion factor
0-100 $\mu\text{S}/\text{cm}$	0.60
100-1,000 $\mu\text{S}/\text{cm}$	0.71
1-10 mS/cm	0.81
10-100 mS/cm	0.94

4.6 Sample Test

4.6.1. Rinse conductivity electrode in distilled or pure water, dry it, and submerge it in the sample solution. Stir the solution briefly and allow it to stay in the sample solution until a stable reading is reached and  icon appears on LCD, then get the reading value, which is the conductivity value of the solution.

4.6.2. During the process of calibration and measurement, the meter has self-diagnosis functions, indicating the relative information as below: Table – 8.

Table – 8 Self-diagnosis information of conductivity measurement mode

Display Icons	Contents	Checking
Err 1	Wrong conductivity calibration solution or the meter recognition of calibration solution is out of range.	<ol style="list-style-type: none"> 1. Check whether conductivity calibration solution is correct. 2. Check whether the meter connects the electrode well. 3. Check whether the electrode is damaged.
Err 4	Press  key when measuring value is not stable during calibration.	Press  key after  icon appears.
Err 5	During calibration, the measuring value being unstable for over 3 minutes.	<ol style="list-style-type: none"> 1. Shake the electrode to eliminate bubbles in electrode head. 2. Replace with new conductivity electrode.

4.6.3. Factory default setting

For factory default setting, please refer to parameter setting P7 (Section 4.7.2). With this function, all calibration data is deleted and the meter restores to the theory value. Some functions restore to the original value. When calibration or measurement fails, please restore the meter to factory default setting and then perform re-calibration or measurement. Please note once set the factory default, all the data deleted will be irretrievable.

4.7 Parameter Setting

Table-9

Symbol	Parameter setting content	Parameter	Factory default setting
P1	Select electrode constant	0.1, 1.0, 10	1.0
P2	Select reference temperature	15 - 30 °C	25°C
P3	Adjust temperature compensation coefficient	0.00 - 9.99%	2.00%
P4	Adjust TDS Factor	0.40 – 1.00	0.71
P5	Select temperature unit	°C - °F	°C
P6	Clear stored data	No – Yes	No
P7	Restore to factory default	No – Yes	No

4.7.1 How to do the parameter setting:













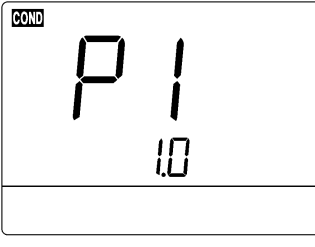





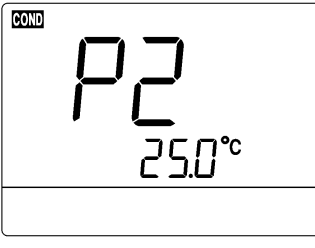





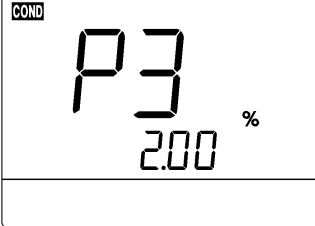



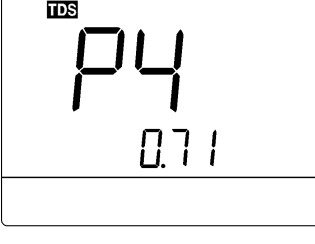

In measurement mode, long press  to enter parameter setting P1. Then press  or  to change menu from P1 to P2...P7. For details, please see Table-10.

Table-10 pH Parameter Setting

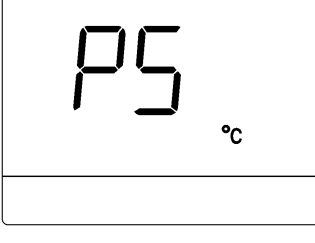
	<p>P1 — Select electrode's constant (1.0—10.0—0.1)</p> <ol style="list-style-type: none"> 1. Long press  to enter P1 2. Press  , "1.0" flashes, press  to choose 1.0→10.0→0.1; press  to confirm 3. Press  to enter P2, or press  to return to measurement mode.
	<p>P2—Select reference temperature (25.0°C—18.0°C—20.0°C)</p> <ol style="list-style-type: none"> 1. Press  , "25.0°C" flashes, press  or  to adjust temp. from 15°C to 30°C; press  to confirm. 2. Press  to enter P3, or press  to return to measurement mode.
	<p>P3—Adjust temp. compensation coefficient (0.00-9.99%)</p> <ol style="list-style-type: none"> 1. Press  , "2.00" flashes, press  or  to adjust from 0.00-9.99; press  to confirm. 2. Press  to enter P4, or press  to return to measurement mode.

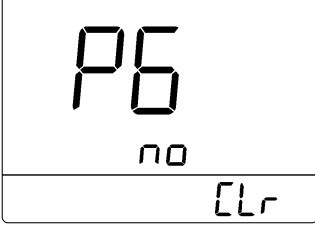
 <p>TDS P4 0.71</p>	<p>P4—Adjust TDS Factor (0.40-1.00)</p> <ol style="list-style-type: none"> 1. Press ENTER , “0.71” flashes, press  or  to adjust from 0.40-1.00; press to confirm. 2. Press  to enter P5, or press CAL MEAS to return to measurement mode.
 <p>P5 °C</p>	<p>P5 —(°C—°F)</p> <ol style="list-style-type: none"> 1. Press ENTER , “°C” flashes, press  , “°F” flashes; when parameter flashes, press ENTER to confirm. 2. Press  to enter P6, or press CAL MEAS to return to measurement mode.
 <p>P6 no CLR</p>	<p>P6 — Clear storage (No—Yes)</p> <ol style="list-style-type: none"> 1. Press ENTER , “No” flashes, press  to choose No→Yes; press ENTER to confirm No— not to clear data storage; Yes—clear all data storage 2. Press  to enter P7, or press CAL MEAS to return to measurement mode.
 <p>P7 no</p>	<p>P7 — Return to factory default mode (No—Yes)</p> <p>Press ENTER , “No” flashes, press  to choose No→Yes; Press ENTER to confirm, the meter returns to measurement mode.</p> <p>No— not return to factory default mode; Yes—return to factory default mode</p>

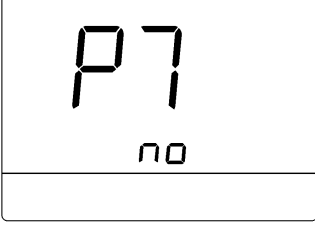
4.8 Conductivity Electrode’s Maintenance

4.8.1. Always keep the conductivity electrode clean. Before taking a measurement, rinse the electrode in pure water. It is recommended to rinse it again in the sample solution. When submerge the electrode in solution, stir the solution briefly to eliminate air bubbles and allow it to stay until a stable reading is reached. Conductivity electrodes are usually stored dry. For conductivity electrodes that haven’t been used for a long time, users should soak the electrode in 12.88 mS calibration solution for 5-10 minutes, or to soak it in tap water for 1 to 2 hours. Rinse the electrode in pure water after measurement.

4.8.2. The sensing rod of Model 2301T-S conductivity electrode is coated with platinum black to minimize electrode polarization and expand measuring range. The platinum black coating adopted our special processing technology, which improves the electrode performance and the firmness of the coating. If the platinum black electrode is stained, gently clean the electrode with soft brush in warm water containing detergent or alcohol.

5 Complete Kit

	Content	Quantity
5.1	EC700 Benchtop Conductivity Meter	1
5.2	2301T-F Plastic Combination Conductivity Electrode	1
5.3	Conductivity standard calibration solutions: (84 μ S/1413 μ S /12.88mS, 50ml for each)	1 for each
5.4	9V Power Adapter	1
5.5	Electrode Holder	1 set
5.6	Instruction Manual	1

6 Warranty

We warrant this instrument to be free from defects in material and workmanship and agree to repair or replace free of charge, at option of APERA INSTRUMENTS, LLC, any malfunctioned or damaged product attributable to responsibility of APERA INSTRUMENTS, LLC for a period of **two years** from the delivery (a **six-month** limited warranty applies to probes). This warranty does not apply to defects resulting from actions such as misuse (violation of the instructions in this manual or operations in the manner not specified in this manual), improper maintenance, or unauthorized repairs. Warranty period is the time limit to provide free service for the products purchased by customers, not the service life of the tester or probe.

APERA INSTRUMENTS, LLC

Address: 6656 Busch Blvd, Columbus Ohio 43229

Tel: 1-614-285-3080

Email: info@aperainst.com

Website: www.aperainst.com