

Instruction and Operation Manual

PCE-DPM 10

Portable Dew Point Meter



Dear Customer,

Thank you for choosing our product.

Please read the operating instructions in full and carefully observe it before starting up the device. The manufacturer cannot be held liable for any damage that occurs as a result of non-observance or non-compliance with this manual.

Should the device be tampered with in any manner other than a procedure that is described and specified in the manual, the warranty is cancelled and the manufacturer is exempt from liability.

The device is designed exclusively for the described application.

PCE INSTRUMENTS offers no guarantee for the suitability for any other purpose. PCE INSTRUMENTS is also not liable for consequential damage resulting from the delivery, capability or use of this device.

Table of Contents

1 Safety instructions.....	4
2 Registered trademarks.....	6
3 RF Exposure Information and Statement.....	7
4 Application.....	8
5 Features.....	8
6 Technical data.....	9
6.1 General	9
6.2 Electrical data.....	10
6.3 Accuracy	10
7 Dimensional drawing.....	11
8 Installation.....	12
8.1 Installation procedure.....	13
8.2 Electrical connection.....	14
8.3 Replace the sensor unit.....	14
9 Operation.....	16
9.1 Buttons and connectors.....	16
9.2 Symbols on screen.....	17
9.3 Home screen	17
9.3.1 Home Screen operations.....	18
9.4 Menu.....	19
9.4.1 Device settings.....	22
9.4.2 Sensor Settings.....	23
9.4.3 Logger.....	24
9.4.4 Files.....	25
9.4.5 Device info.....	26
9.4.6 Service info.....	26
9.4.7 Site information.....	26
9.4.8 Wireless printer.....	27
9.5 Graph.....	27
9.6 Print files.....	28
9.7 Smart features.....	29
9.8 Export logger files to a PC.....	30
9.9 Export PDF report to PC.....	31
9.10 Update the device Firmware.....	32
10 Measuring chambers (Optional).....	33
10.1 Standard measuring chamber (A699 3500).....	33
10.2 By-pass measuring chamber (A699 3501).....	33
11 Calibration.....	34
11.1 Dew point calibration.....	34
11.2 Pressure calibration	34
12 Maintenance.....	35
13 Disposal or waste.....	35

1 Safety instructions

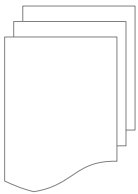

Please check if this instruction manual matches the product type.

Please observe all notes and instructions indicated in this manual. It contains essential information which must be observed before and during installation, operation, and maintenance. Therefore this instruction manual must be read carefully by the technician as well as by the responsible user/qualified personnel.

This instruction manual must be available at the operation site of the dew point meter at any time. In case of any obscurities or questions, regarding this manual or the product, please contact the manufacturer.



WARNING!

Compressed air!

Any contact with quickly escaping air or bursting parts of the compressed air system can lead to serious injuries or even death!

- Only use pressure tight installation material.
- Avoid that persons get hit escaping air or bursting parts of the instrument.
- The system must be pressure-less during maintenance work.



WARNING!

Voltage used for supply!

Any contact with energized parts of the product may lead to an electrical shock, which can lead to serious injuries or even death!

- Consider all regulations for electrical installations.
- The system must be disconnected from any power supply during maintenance work.
- Any electrical work on the system is only allowed by authorized qualified personal.



ATTENTION!

Permitted operating parameters!

Observe the permitted operating parameters. Any operation exceeding this parameters can lead to malfunctions and may lead to damage on the instrument or the system.

- Do not exceed the permitted operating parameters.
- Make sure the product is operated in its permitted limitations.
- Do not exceed or undercut the permitted storage and operating temperature and pressure.

General safety instructions

- It is not allowed to use the product in explosive areas.
- Please observe the national regulations before/during installation and operation.

Remarks

- It is not allowed to disassemble the product.



ATTENTION!

Measurement values can be affected by malfunction!

The product must be installed properly and frequently maintained. Otherwise, it may lead to wrong measurement values, which can result in wrong results.

Storage and transportation

- Make sure that the transportation temperature of the dew point meter is between $-30 \dots +70^{\circ}\text{C}$.
- For transportation it is recommended to use the packaging that comes with the sensor.
- Please make sure that the storage temperature of the sensor is between $-20 \dots +50^{\circ}\text{C}$.
- Avoid direct UV and solar radiation during storage.
- For the storage the humidity must be $<80\%$ rH with no condensation.

2 Registered trademarks

MODBUS®	Registered trademark of the Modbus Organization, Hopkinton, USA
Android™, Google Play	Registered trademarks of Google LLC

3 RF Exposure Information and Statement

This equipment complies with FCC RF radiation exposure limits set forth for an uncontrolled environment. This equipment should be installed and operated with minimum distance of 20 cm between the radiator and your body.

This device complies with part 15 of the FCC rules. Operation is subject to the following two conditions: (1) this device may not cause harmful interference, and (2) this device must accept any interference received, including interference that may cause undesired operation.

NOTE: The manufacturer is not responsible for any radio or TV interference caused by unauthorized modifications to this equipment. Such modifications could void the user's authority to operate the equipment.

NOTE: This equipment has been tested and found to comply with the limits for a Class B digital device, pursuant to part 15 of the FCC Rules. These limits are designed to provide reasonable protection against harmful interference in a residential installation. This equipment generates uses and can radiate radio frequency energy and, if not installed and used in accordance with the instructions, may cause harmful interference to radio communications. However, there is no guarantee that interference will not occur in a particular installation. If this equipment does cause harmful interference to radio or television reception, which can be determined by turning the equipment off and on, the user is encouraged to try to correct the interference by one or more of the following measures:

- Reorient or relocate the receiving antenna.
- Increase the separation between the equipment and receiver.
- Connect the equipment into an outlet on a circuit different from that to which the receiver is connected.
- Consult the dealer or an experienced radio/TV technician for help
- This device and its antenna(s) must not be co-located or operating in conjunction with any other antenna or transmitter.

4 Application

The PCE-DPM 10 is a dew point meter that is designed to monitor the dew point in the industrial application within the permissible operating parameters. These parameters can be found in the [Technical data](#) chapter on page 9.

The PCE-DPM 10 can measure and display the following values for compressed air or gas:

- Dew point, default unit: °C Td
- Humidity, default unit: % rH
- Temperature, default unit: °C
- Pressure, default unit: bar (g)

The PCE-DPM 10 Dew Point Meter is mainly used in compressed air systems in industrial environments. It is not developed to be used in explosive areas. For the use in explosive areas please contact the manufacturer.

5 Features

- Measures dew point, temperature, humidity, and pressure
- Two sensor solutions available:
 - Sensor A: Standard sensor unit with a range of -100 ... +20°C Td
 - Sensor B: Economic sensor unit with a range of -50 ... +50°C Td
- Smart dew point prediction
- Integrated pressure sensor
- Modern color touch screen interface
- Data logger, USB interface, and wireless connection to a portable printer
- Measuring/parking chamber, designed for fast sensor response
- Application software included
- Integrated camera for more elegant reports
- ISO8573-1 Class indication

6 Technical data

6.1 General

 Contains FCC ID: 2ADHKWINC3400	
Parameters	Standard unit dew point: °C Td Standard unit temperature: °C Other units: °F, K Standard unit humidity: % rH Standard unit pressure: bar(g), MPa(g)
Principle of measurement	Capacitive method, Oscillating crystal
Sensor	Sensor A: QCM + Polymer Sensor B: Polymer Temperature: Pt100 Pressure: Piezo resistive type (only with Sensor A1370)
Measuring medium	Air, N ₂ , O ₂ , Argon, CO ₂ Note: The CO ₂ measurements with the A1371 sensor are limited to -40 °C Td.
Measuring range	Sensor A: -100 ... +20°C Td Sensor B: -50 ... +50°C Td Pressure: 0 ... 1.5 MPa (g) Temperature: -30 ... +50°C
Response time (T90) @4 l/min	Sensor A 0 °C Td → -80 °C Td ≤ 420 sec -80 °C Td → 0 °C Td ≤ 90 sec
	Sensor B 0 °C Td → -50 °C Td ≤ 280 sec -50 °C Td → 0 °C Td ≤ 65 sec
Operating temperature	Medium: -30 ... +50°C Ambient: 0 ... +40°C
Operating pressure	-0.1 ... 1.6 MPa (g) *
Humidity	Medium: 0 ... 90% rH Ambient: 0 ... 80% rH
Casing material	PC + ABS
Protection class	IP30
Dimensions	See dimensional drawing on page 11
Display	3.5" color LCD touch screen

Weight	2.7 kg complete set in transport case
Camera	5.0 megapixels (only with smart features option)
Data Logger	Integrated mass storage, 100 Million values
Process connection	G1/2" for direct sensor connection, Measuring chamber with 6 mm hose quick coupling

* At least 0.3 MPa(g) is needed for the measuring chamber supplied with the instrument. For low-pressure measuring below 0.3 MPa(g), choose the optional bypass measuring chamber A699 3501.

6.2 Electrical data

Power supply	USB charger: 5 V, 3 A Connector: USB-C
Battery	Operating time on one charge: about 8 h Charging time until full: about 3 h

6.3 Accuracy

Accuracy	Dew point: ±1°C Td (0 ... 20°C Td) ±2°C Td (-70 ... 0 / +20 ... +50°C Td) ±3°C Td (-100 ... -70°C Td) Temperature: ± 0.3°C Pressure: 0.5% FS
Repeatability	±0.5°C
Stated accuracy at	Ambient/process temperature: 23°C ± 3°C Ambient humidity: 0 ... 80% rH, no condensation

7 Dimensional drawing

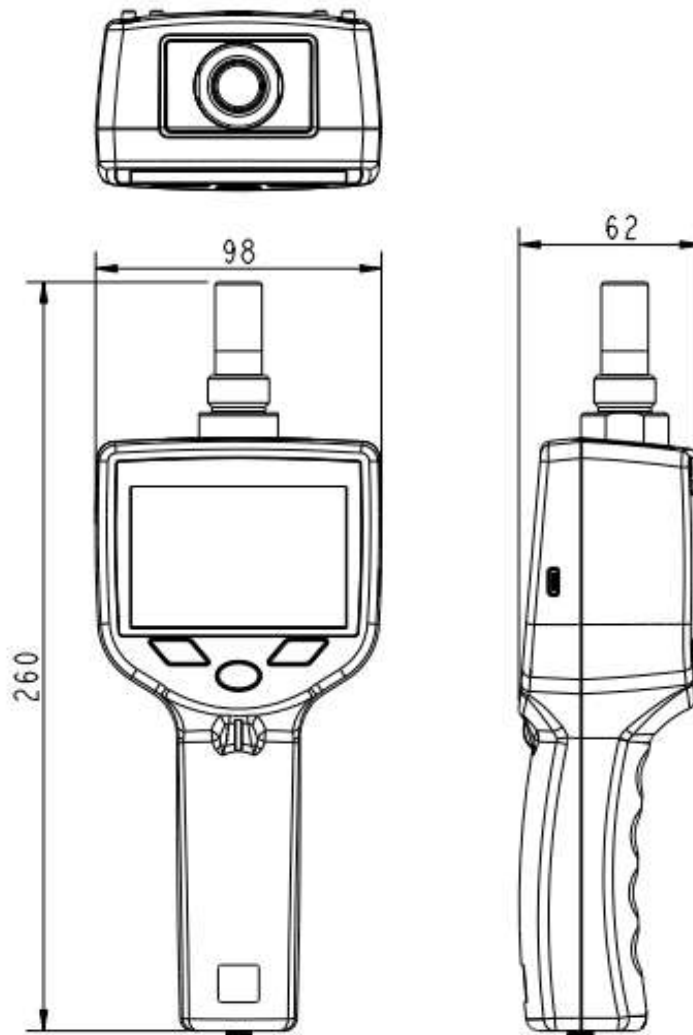

8 Installation

Please make sure that all components listed below are included in your package.

Qty	Description	Item No.
1	PCE-DPM 10 Portable Dew Point Meter with data logger - Measuring chamber with parking function - USB-OTG memory stick - 1.5 m PTFE hose 6 mm with a quick coupling at one end - Certificate of calibration - USB charger with USB-C cable - Transport case	P600 0520
1	Sensor unit A or Sensor unit B	A1370 or A1371
1	Parking / Measuring chamber (included in set P600 0520)	A699 3500
1	1.5 m PTFE hose with a quick coupling at one end (included in set P600 0520)	A554 0003
1	USB charger with USB cable (included in set P600 0520)	A554 0018
1	Transport case (included in set P600 0520)	A554 0019
1	USB-OTG Memory Stick with the USB-A and USB-C connectors (included in set P600 0520)	A554 0124

8.1 Installation procedure

The following steps explain the procedure of an appropriate installation.

1. Make sure that the teflon hose is dry and clean.

Attention:

Wet and contaminated hoses can negatively affect the measurement and must be replaced with a dry and clean one.



2. Connect the teflon hose to the measuring chamber.



3. Connect the quick coupling at the other end of the teflon hose to the process.

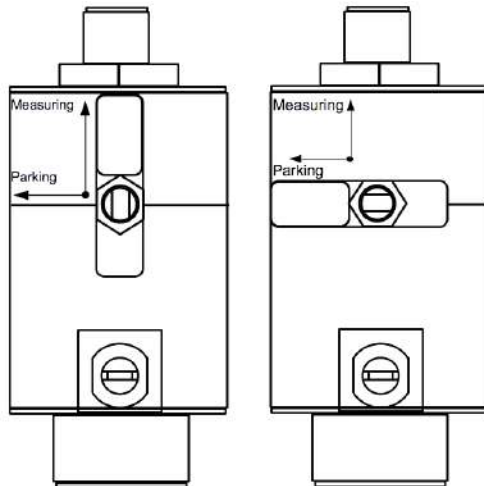

5. Turn the handle on the chamber to the "Measuring" position.

Note: The parking measuring chamber is mounted permanently on the sensor head to keep the sensor dry. To measure, the handle on the chamber must be turned into the "Measuring" position. After finishing the measurement, please turn it to the "Park" position.

6. Turn on the device.

7. Start to measure using the touch screen. For more information, see Chapter [9 Operation](#).

8.2 Electrical connection

Please charge the Dew Point Meter if the battery is low. To do so, use the charger that is included in the delivery package.

1. Connect the USB cable to the device and the charger.
2. Plug in the charger to your AC supply outlet.

The device starts to indicate the charging progress. Always try to charge to 100%.

8.3 Replace the sensor unit

For service or calibration, the sensor units can be exchanged easily.

Before exchanging the sensor units, please make sure that the new one has the dew point range that matches your need:

- Sensor A: -100 ... +20 °C Td
- Sensor B: -50 ... +50 °C Td

To exchange the sensor units, follow the below steps:



1. Open the two screws at the back of the instrument.



2. Pull the sensor unit together with the measuring chamber out of the main unit.

3. Screw the measuring chamber off the sensor unit.

4. Screw the measuring chamber onto the new sensor unit.

5. Insert the new sensor unit together with the measuring chamber back to the sensor unit.

6. Tighten the two screws.



ATTENTION!

Do not remove or touch the sinter cap on the sensor unit. The sinter cap protects the sensor element from dust and particles. Wrong handling may effect or even destroy the sensitive sensor element!

9 Operation

9.1 Buttons and connectors



Logger Menu	To access the Logger menu to set up the logging rate and mode.
Power On/off	To turn on or off, keep the button pressed for >3 sec.
Measurement	To quickly record a file of the current measurements for later printing.

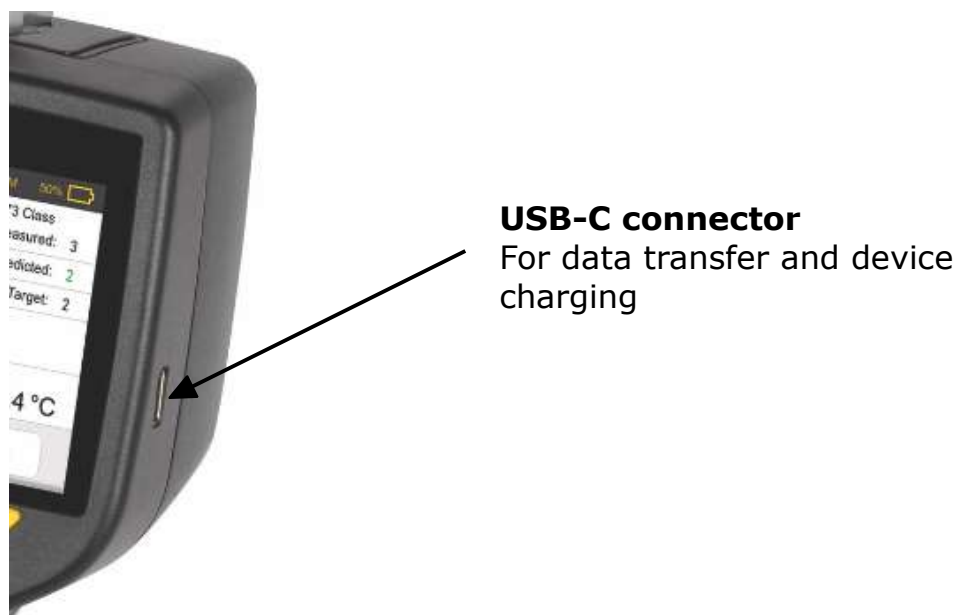

9.2 Symbols on screen



Indicates that the sensor unit calibration is expired and needs a calibration. Please contact your supplier or the manufacturer for a calibration service.



Indicates that the device is currently connected to a PC or to a USB-OTG memory stick or the OTG function is enabled.

Logger: Stopped

Indicates the logger state.

- "Logger: Stopped" indicates that the logger is currently not running.
- "Logger: Started" indicates that the logger is running and recording the measurement data.



Indicates that a wireless printer is connected to the device.

09:59 AM

Shows the current device time.



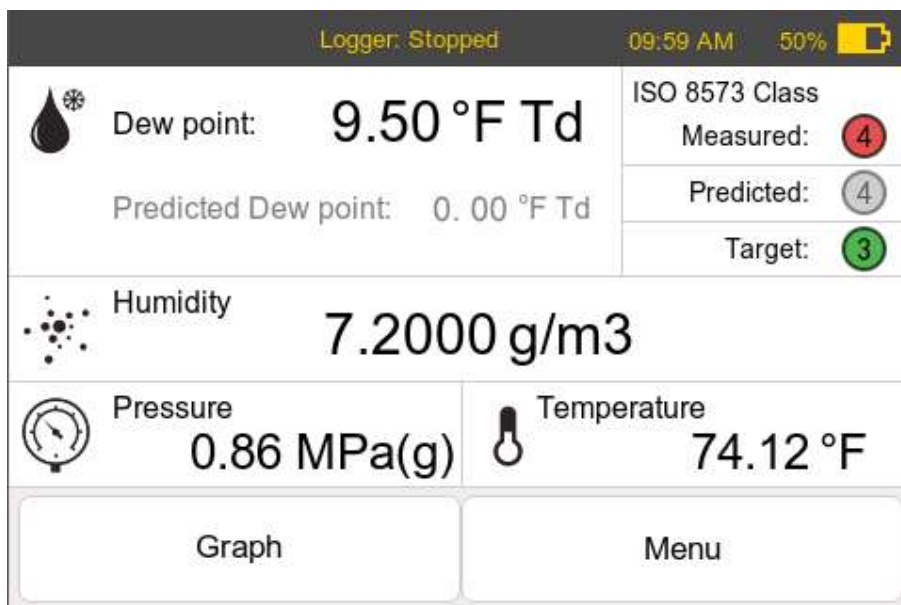

10%

Indicates the battery capacity of the device. It also indicates whether the battery is draining or is being charged.

9.3 Home screen

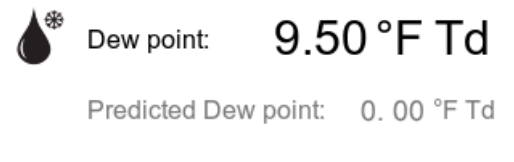
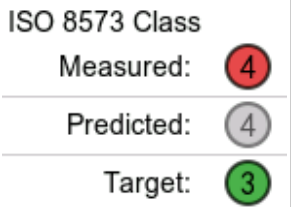
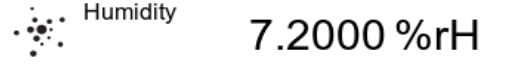

9.3.1 Home Screen operations

Button	Function
	<p>To open the device menu. See 9.4 Menu on page 19 for a detailed description of the menu.</p>
	<p>To enter the graph view. See 9.5 Graph on page 27 for a detailed description of the menu.</p>
	<p>Shows the measured dew point value in the selected unit. The predicted dew point is available only if the PCE-DPM 10 is ordered with smart features. To change the unit of the dew point, press this pane, and a pop-up window appears for you to change the unit.</p>
	<p>Shows the Class according to the ISO 8573-1. Measured indicates the Class of the actual measured value. Predicted indicates the Class of the predicted dew point. Target indicates the expected Class that you set.</p>
<p>To set the Target class, press this pane.</p>	
	<p>Shows the alternative humidity unit. To change the unit, press the value, and a pop-up window appears with a list of alternative units for you to select.</p>
	<p>Shows the measured pressure. To change the unit, press the value, and a pop-up window appears with a list of alternative units for you to select.</p>



Shows the measured temperature. To change the unit, press the value, and a pop-up window appears with a list of alternative units for you to select.

9.4 Menu

The device menu offers different operations, such as connecting a printer, reading device information, and many more.

Below is the tree structure of the device menu. The following sections provide detailed description for each menu.

Menu

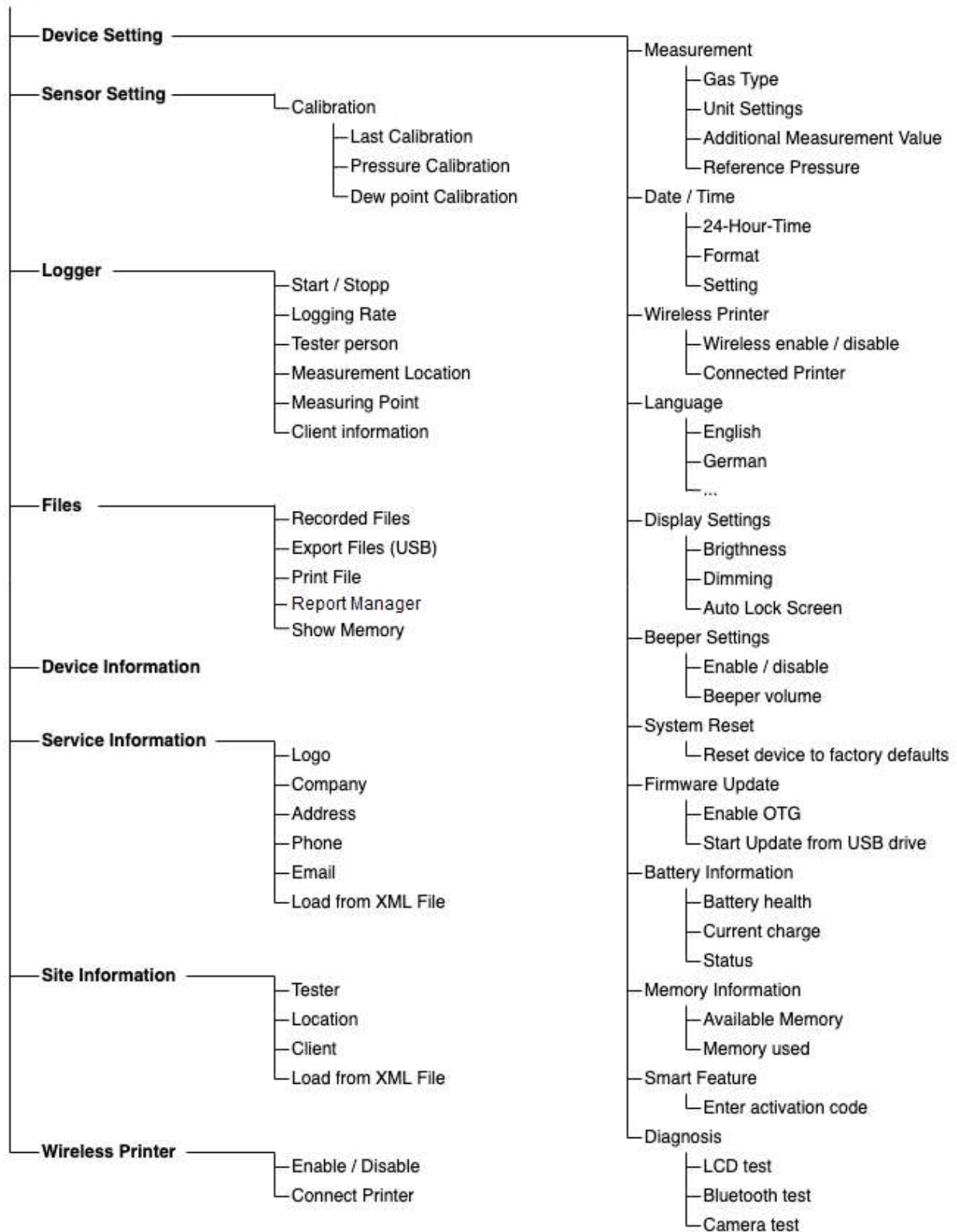

The following table describes functions of all menus.

Device Settings	To view or change the measurement settings, date and time, Wireless printer, Language, Display settings, Beeper settings, system reset, firmware update, battery info, memory info, smart features, and diagnoses. For more information, see Section 9.4.1 on page 22.
Sensor Settings	To view the last calibration and apply pressure and/or dew point calibrations. To view or change the measurement settings. For more information, see Section 9.4.2 on page 23.
Logger	To view or change the logger status, logging rate, tester person, measurement location, measuring point, client information. For more information, see Section 9.4.3 on page 23.
Files	To view the recorded files, export files, print files, and show memory usage. For more information, see Section 9.4.4 on page 25.
Device info	To view the device information such as serial number, firmware, and hardware version. For more information, see Section 9.4.5 on page 26.
Service info	To enter the service company information that is to be shown on the report. For more information, see Section 9.4.6 on page 26.
Site information	To enter the customer information where the audit is performed. For more information, see Section 9.4.7 on page 26.
Wireless printer	To connect and maintain the connection to a wireless printer. For more information, see Section 9.4.8 on page 26.

9.4.1 Device settings

Enables you to configure the device settings.

Measurement	<ul style="list-style-type: none"> • Gas type <ul style="list-style-type: none"> ◦ To select the gas type in which the measurement is performed. Available gases are: Air, N₂, O₂, Argon and CO₂ • Unit settings <ul style="list-style-type: none"> ◦ To select the unit for Temperature: °C or °F ◦ To select the unit for Pressure: bar(g), MPa(g), or psi(g) • Additional measurement value <ul style="list-style-type: none"> ◦ To select the humidity unit to be displayed additionally: % rH, g/m³, mg/m³, g/m³ atm., mg/m³ atm., ppm(v), g/kg or °C Td atm. • Reference Pressure <ul style="list-style-type: none"> ◦ To enter a constant reference pressure if you are using a pressure reducer
Date / Time	<ul style="list-style-type: none"> • To set the device time and date. • To change the format of date and time display as needed.
Wireless Printer	<ul style="list-style-type: none"> • To connect with a wireless printer and print a test page. • See Section 9.4.8 Wireless printer on page 27 for details.
Language	To change the language of the user interface. A list of available languages is shown in the menu.
Display Settings	<ul style="list-style-type: none"> • To adjust the display brightness and to enable the automatic adjustment of the brightness to save battery life. • To enable the screen to be automatically locked when not used
Beeper Settings	To determine whether the device beeps every time the screen is touched.
System Reset	To reset the system to factory defaults. Attention: This will delete all user-specified settings.
Firmware	<ul style="list-style-type: none"> • To update the firmware of the device using the

update	USB-OTG memory stick. <ul style="list-style-type: none"> • See the Section 9.10 on page 32 for detailed instruction.
Battery info	Shows the current state and capacity of the battery.
Memory Info	Shows the internal memory capacity.
Smart Feature	<ul style="list-style-type: none"> • To activate the smart features. <p>Note: If the smart features are purchased in the initial order, they are activated by default. If smart features are ordered afterward or separately, enter the activation code you received for an upgrade.</p>
Diagnosis	To execute a self diagnosis. Use it when you are experiencing a problem.

9.4.2 Sensor Settings

Enables you to perform the sensor calibration.

Calibration	
Last Calibration	Shows the calibration status of the sensor unit. You can see when was the last calibration of the installed sensor unit.
One-point calibration Pressure	To perform a user one-point calibration of the pressure measurement.
One-point calibration dew point	To perform a user one-point calibration of the dew point measurement.
Multi-point calibration dew point	To perform a user multi-point calibration of the dew point measurement.
Measurement	Same settings with the ones in the Device Settings > Measurement menu.

Note:

A new instrument is calibrated ex-work and ensures accurate measurements. Whenever you receive a new instrument, you do not need to perform the dew point calibration.

The dew point calibration must be performed only by professionals. Please contact your service provider for the calibration service.

9.4.3 Logger

Enables you to configure the device internal logger.

Start / Stop	<ul style="list-style-type: none">• To start or stop the logger by switching the toggle.
Logging Rate	<ul style="list-style-type: none">• To set the logging rate. It defines at which rate the values are logged.• You can select one sample / 1 second up to one sample / 60 second.
Tester*	<ul style="list-style-type: none">• To enter the Tester name (user of the device).• To be shown on the printed reports.
Measurement Location*	<ul style="list-style-type: none">• To enter the Measurement location, where the measurement is performed. For example Compressor House 1• To be shown on the printed reports.
Measuring Point	<ul style="list-style-type: none">• To enter the measuring point where the air is sampled. For example, Outlet Dryer 1• To be shown on the printed reports.
Client Information*	<ul style="list-style-type: none">• To enter the name of your client, where the measurement is carried out. For example, Customer Co. Ltd.• To be shown on the printed reports.

* The three settings are available in both the Logger and the Site Information menus. If you change these settings in one menu, the device will synchronize the changes to the other menu.

9.4.4 Files

Enables you to view logger files and export the PDF report based on ISO08573-1 standard to a USB drive, and perform file operations.

Recorded Files	<ul style="list-style-type: none"> • Shows the list of recorded files. • To view information of a file, select the file. • To delete a file permanently, press Delete. • To show the print preview and to show the measurement results on the device, press Preview Print. • To print a file using the wireless printer, press Print on the Print Preview screen.
Export Files (USB)	<ul style="list-style-type: none"> • Shows the list of clients. • To export files of one or more clients, follow the below steps: <ol style="list-style-type: none"> 1. Insert a USB drive. 2. Select the target clients, and then press Export. The files of the selected clients are saved as CSD files on the USB drive. 3. Use the free S4A software to open the files on a PC for analysis.
Print File	<ul style="list-style-type: none"> • Shows the list of recorded files. • To show the information of a file, select the file. • To show the print preview and to show the measurement results on the device, press Preview Print. • To show the average values of the measurement results, press Average. By default the measurement results of the last point are displayed. To switch back to the last point values, click Last point. • To print a file via the wireless printer, press Print.
Report Manager	<ul style="list-style-type: none"> • To export the PDF report to USB drive, click Menu > Files > Report Manager > Client List > Select a client. Then click Export for a specific report, or click Export All to export all reports.
Show Memory	<ul style="list-style-type: none"> • Shows the Memory status including total storage and the used up storage.

9.4.5 Device info

Shows the basic information of the hand-held unit.

- Model name
- Serial number of the main unit
- Firmware version of the main unit
- Hardware version of the main unit
- Installed sensor type
- Serial number of the sensor unit
- Firmware version of the sensor unit
- Hardware version of the sensor unit

9.4.6 Service info

Enable you to enter the service information that is to be shown on the printed reports.

Logo	<ul style="list-style-type: none"> • To upload your company logo from a connected USB drive. • File Format: BMP • File Size: 256 x 170 px; max. 1 MB; 24 bit color depth, black and white
<hr/>	
Company	<ul style="list-style-type: none"> • To enter your company name
<hr/>	
Address	<ul style="list-style-type: none"> • To enter your address
<hr/>	
Phone	<ul style="list-style-type: none"> • To enter your phone number
<hr/>	
Email	<ul style="list-style-type: none"> • To enter you contact email address

The Service info can also be imported from an XML file. Scroll down and click *Load Service info from XML file* to select a file from the USB drive.

9.4.7 Site information

Enables you to enter the site information that is to be shown on the printed reports.

Tester	To enter the name of the tester who performs the measurement.
<hr/>	
Location	To enter the measurement location where the measurement is performed. For example, Compressor

House 1.

Client To enter the name of your client where the measurement is carried out. For example Customer Co. Ltd.

The Site information can also be imported from an XML file, scroll down and click **Load Service info from XML file** to select a file from the USB drive.

9.4.8 Wireless printer

Enables you to connect a wireless printer.

Wireless enable To activate or deactivate the wireless connection, switch the toggle. To connect a printer, activate it.

Connected printer To show nearby printers, press this button, and then select the printer to connect or to disconnect.

9.5 Graph

The PCE-DPM 10 provides graphical analysis for the measurement directly on the device.

The graph shows a separated curve for each measurement value. You can activate or deactivate the curves. The scaling of the Y-axis can be set automatically or adjusted manually.

Please follow the below instructions.

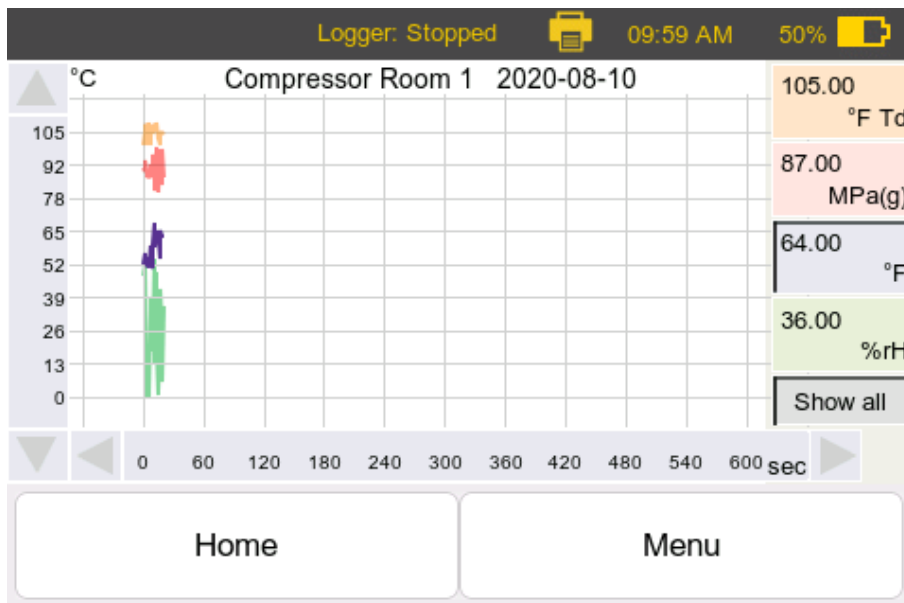

Graph Screen on the PCE-DPM 10

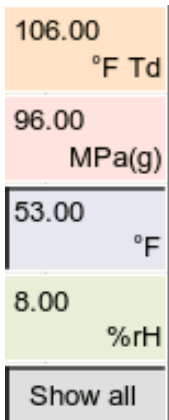

- To show a curve for a measurement parameter separately, click the parameter pane on the right side.
- To show all curves in one graph, select **Show all**.

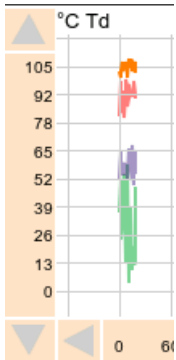

- The Y-axis on the left side will automatically adjust its scaling, depending on the chosen parameter.

Y-axis scale setting

Minimum

Maximum

Interval

Auto scaling

- You can scale the axis manually by clicking on the axis. The below pop-up appears.
 - Auto scaling will automatically scale the axis to fit the graph.
 - If Auto scaling is not selected, enter the minimum, maximum, and interval to scale the axis manually.

9.6 Print files

This menu is similar to the File menu.

You can select the files to be printed:

- Show the list of recorded files.
- Show the file information by selecting a file.
- Show the print preview and show the measurement results on the device by clicking Preview Print.
- Print a file using the wireless printer by clicking Print.

9.7 Smart features

The PCE-DPM 10 can be optionally ordered with Smart Features (A1373).

Smart features include the following:

- Measurement Snapshot
- Dew point end value prediction
- Camera
- Report manager

This function is used to create and export the PDF file based on ISO 8573-1 standard. For the operation, see section 9.9.

Notes:

- If the smart features are purchased in the initial order, they are activated by default.
- If smart features are ordered afterward or separately, you must enter the required information for the upgrade in the activation menu, please read 9.4.1 Device settings on Page 22 for details.

The Smart features are described in detail as follows.

Measurement Snapshot	<ul style="list-style-type: none"> • The snapshot feature enables you to save the current measurement values into a snapshot digital file. This means all currently displayed values are saved in a single file. • The file contains all information that is needed for a dew point audit: <ul style="list-style-type: none"> ◦ Client/company name ◦ Measurement location ◦ Measurement point ◦ Measurement results ◦ Date and Time ◦ Measurement performed by ◦ Device & Sensor information • The file can be used to create useful audit reports directly on site by using the wireless printer.
Dew point end value prediction	<ul style="list-style-type: none"> • The PCE-DPM 10 offers a unique dew-point-end-value-prediction algorithm as a built-in technology.

- Based on the dew point measurement curve, the algorithm can predict the end value before the end value is actually reached.
- This feature enables you to predict the dew point end value in a minimum amount of time. It helps on-site engineers perform faster dew point audits and save time.

Camera

- Part of the Snapshot feature, and helps you facilitate the audit process. It allows you to take a picture of the measurement point, making it easier to understand the report and follow up later. This improves the documentation of dew point audit on site.
-

9.8 Export logger files to a PC

You can export logger files to a PC using the included USB drive and the free software S4A. Exported files are in the *.CSD format and can be read only using the S4A software, which can be downloaded from www.suto-itec.com.

To export the data to Excel or CSV files and analyze them using S4A, do the following:

1. Open the PCE-DPM 10 device menu and enter the **Files** menu (For more details, see 9.4.4 Files on page 25).
2. Export files to the USB drive using the following steps:
 - A. Open the **Files** menu.
 - B. Insert a USB drive.
 - C. Press **Export File (USB)**. You can see all client names that you ever configured in the Device Settings > Logger menu.
 - D. Press a client name as needed.
 - E. To export a log file under this client to the USB file, press **Export** following the log name. To export all log files of this client, press **Export All**.
3. On the PC, open the S4A software and insert the USB drive.
4. In S4A, click **File** in the top left of the screen.
5. In the **File** menu that appears, navigate to the path of the USB drive. All available CSD files are displayed.
6. Select a file and open it in S4A for analysis.

9.9 Export PDF report to PC

After purchasing the smart feature, you can create an ISO 8573-1 based PDF report and export it to a PC using the included USB drive.

Follow steps below to create and export the PDF report:

1. Open the PCE-DPM 10 device menu and enter the **Files** menu (For more details, see 9.4.4 Files on page 25).
2. Follow steps below to create and export reports to the USB drive:
 - A. Open **Files** menu.
 - B. Insert a USB drive.
 - C. Press **Report Manager**. You can see all client names that you ever configured in the **Logger** menu.
 - D. Press a client name as needed.
 - E. To export a PDF report under this client to the USB drive, press **Export** following the PDF name. To export all PDF reports of this client, press **Export All**.
3. Insert the USB drive to a PC.
4. In the PC, navigate to the path of the PDF report by accessing the PCE-DPM 10 folder > Client name folder > Report manager folder. In the Report manager folder all available PDF reports under the client are displayed.
5. Copy the PDF reports to your PC for following operation like printing or sending by email etc.

9.10 Update the device Firmware

Before updating the device firmware, copy the new firmware to the USB drive.

Before updating the firmware, make sure that the battery capacity is larger than 20%.

1. Load the new firmware file on the USB drive.
2. Power on the PCE-DPM 10 device.
3. Connect the USB drive to the PCE-DPM 10 USB-C port.
4. On the touchscreen, navigate to **Menu > Device Settings > Firmware update.**
5. Enable the OTG function (to enable reading from USB drive).
6. Press **Next** and follow the on-screen instructions.

Attentions:

- Make sure that the USB drive is kept plugged in during the update.
- Do not power off the device during update.
- Wait until the update is finished and the device is rebooted back to the home screen.

10 Measuring chambers (Optional)

10.1 Standard measuring chamber (A699 3500)

The PCE-DPM 10 is supplied with a measuring chamber (Item no. A699 3500) with a pressure range of 0.3 ... 1.5 MPa.

This measuring chamber is used to connect the compressed air to the sensor using a 6 mm hose. The measuring chamber comes with a parking function with which the sensor element can be kept in a dry environment when it is not used. This helps decrease the response time of the sensor whenever a new measurement is started.

On the measuring chamber, there is a handle, indicating whether the chamber is currently in the parking or measuring position.

Before starting the measurement, please turn the handle to the "Measuring" position. An internal valve is switched and the sensor is now connected to the compressed air source, and the dry cell is sealed in a separate chamber.

After the measurement is finished, please turn the handle to the "Parking" position.

Remark: To work properly, this measuring chamber type (A699 3500) needs a minimum inlet pressure of 0.3 MPa. For lower pressure applications, the by-pass measuring chamber shall be used (A699 3501).

10.2 By-pass measuring chamber (A699 3501)

The by-pass measuring chamber can be purchased optionally and provides a pressure range of 0.01 ... 1.0 MPa. It has the same advantages as chamber A699 3500, but instead of purging the air into the environment, it comes with a 6 mm quick coupling as the outlet. This enables the chamber to be used in a by-pass measurement.

This chamber must be used in one of the following situations:

- The process application does not allow to purge air into the environment.
- The inlet pressure is below 0.3 MPa.

11 Calibration

The dew point calibration is not necessary when you receive a new instrument. The new instrument is calibrated ex-work and measures accurately. The user dew point calibration should only be performed by professionals. Please contact your service before performing a user calibration.

The exact calibration date is printed on the certificate which is supplied together with the sensor. The accuracy of the sensor is regulated by the on-site conditions, parameters such as oil, high humidity, or other impurities can affect the calibration and furthermore the accuracy. However, we recommend calibrating the instrument at least once per year. The calibration is excluded from the instrument's warranty. For this, please contact the manufacturer.

If the instrument has a slight drift due to aging, temperature, or other effects, a dew point and pressure calibration can be performed.

It is always recommended the instrument be calibrated by the manufacturer. If you want to perform a user calibration, please follow the instructions in the next sections.

11.1 Dew point calibration

See Section 9.4.2 Sensor Settings on Page 23 first before continuing with the calibration.

11.2 Pressure calibration

See Section 9.4.2 Sensor Settings on Page 23 first before continuing with the calibration.

12 Maintenance

To clean the sensor and its accessories it is recommended to use moist cloth only.



ATTENTION!

Do not use isopropyl alcohol to clean the sensor and its accessories!

13 Disposal or waste



Electronic devices are recyclable material and do not belong in the household waste.

The sensor, the accessories and its packings must be disposed according to your local statutory requirements.

The dispose can also be carried by the manufacturer of the product, for this please contact the manufacturer.

PCE Deutschland GmbH

Im Langel 26
59872 Meschede
Germany

Tel: +49 (0) 2903 / 976 99 40

Fax: +49 (0) 2903 / 976 99 99 40

Website: www.pce-instruments.com