



PRODUCTION AND OPERATION EQUIPMENT

www.denios.co.uk/production-and-operation-equipment

ALLIANCE SUPPLIES SDN. BHD.

www.alliance-supplies.com | www.alliancesuppliesonline.com.my | info@alliance-supplies.com | T:+606 3338889/8887/8898

6



PRODUCTION AND OPERATION EQUIPMENT

At DENIOS you will find a wide range of products that help prevent accidents and minimise hazards.

Our high-quality solutions help create a secure environment for your investments and employees and comply with all relevant regulations and standards.

530 Transport trolleys



584 Work chairs and stools



544 Lifting equipment and lifting technology



591 Safety barriers and impact protection



550 Tipping skips



612 Hose and cable bridges



556 Mesh box pallet and accessories



614 Industrial and traffic mirrors



558 Used battery container



622 Security and locking equipment



564 Aluminium boxes



624 Access control



566 Open-fronted storage bins and shelf bins



628 Helmet lamps and torches



568 Big Bags and accessories



630 Scales



570 Grit bin



632 Spark-free tools



574 Storage shelves



635 Cutting tools



578 Equipment cabinets and social room facilities



636 Signs and markings





NEW PRODUCTS FOR 2024

Safety throughout the year - with numerous new solutions and services, and new products from the DENIOS world! Here's an overview of the highlights in this chapter.

Visit our digital showroom and discover the DENIOS Download Center with a wide range of free specialist publications.

6

Crane arms, available in various designs



See page
548

Load arms, available in various designs



See page
549

Safety knives, available in various designs



See page
635

Extended range of company signs



See page
636

Stair-climbing trucks VARIOfit

The professional truck for safe, energy-saving transport, step by step

- Sturdy welded steel design
- Ergonomic safety handles in plastic
- High-quality powder coating, RAL 5010, gentian blue
- 2 easy to manoeuvre, reliable 3-point wheels
- Smooth running tyres in thermoplastic rubber with precision groove ball bearings



VARIOfit
Die perfekte Form
des Transports

- Easy to use with just one hand - even bulky loads are simple to manoeuvre
- Sturdy steel design
- Load surface in high quality MDF board, beech finish
- Smooth running tyres in thermoplastic rubber on plastic rims with precision groove ball bearings
- High-quality powder coating, RAL 5010, gentian blue
- 2 swivel castors with EasySTOP and 2 fixed castors
- Swivel castors with foot guards

Model	Stair-climbing trucks in steel	
Shovel dimensions W x D [mm]	320 x 245	480 x 295
Tyres	TPE	
Overall load capacity [kg]	200	
Order number	272-680-JB	272-696-JB

For more versions of the transport trolley go to www.denios.co.uk

Grip dollies VARIOfit

The "grippy" professional dolly for use across the whole company

- Easy to use with just one hand - even bulky loads are simple to manoeuvre
- 1 or 2 loading surfaces within the frame



Model	Dollies	
Number of levels	1	2
Platform dimensions W x D [mm]	605 x 500	560 x 455
Overall load capacity [kg]*	250	200
Height of loading areas [mm]	185 / /	220 / 775 /
Diameter, Roll [mm]	125	
Order number	272-641-JB	272-642-JB

*All load capacities: for an evenly distributed load on the loading area

Chassis VARIOfit

Easy to manoeuvre chassis for Euro pallets or mesh boxes

- Sturdy angle-steel construction with 4 corner braces
- Loading height (mm): 285 or 650
- Tyre choice: TPE, polyamide, solid rubber - elastic
- Accessories: push-in towing bar (must be ordered with the chassis!)



Chassis variably adjustable - for a shelf height up to 650 mm



Chassis with loading height 285 mm and TPE tyres

Model	Chassis		
Overall load capacity [kg]	500	1050	1200
Tyres	TPE	Polyamide	Solid rubber - elastic
External dimensions W x D [mm]	870 x 1270		
Order number Loading height: 285 mm	272-664-JB	272-665-JB	272-666-JB
Order number Loading height: 650 mm	272-661-JB	272-662-JB	272-663-JB
Accessories	Towing handle with connector		
Order number	272-695-JB		

General purpose plastic trolley DENIOS base-line

Versatile and lightweight trolley with handles and quiet, easy to manoeuvre wheels

- High resistance to acids and alkalis
- Shelves and handle in plastic (PP) with smooth surfaces - easy to clean
- Smooth running TPE swivel castors including 2 with brakes
- Version TOOL: easy open draws (an automatic lock prevents the draw being fully removed by accident)



Available immediately!



BEST price ✓

ORDER AT THE SAME TIME



1

Collection container for hanging at the side, h 200 mm

Order no. 180-045-JB

2

Waste container for hanging at the side, h 470 mm

Order no. 180-043-JB

3

Rectangular containers fit inside, h 180 mm

Order no. 180-044-JB



Version PRO and TOOL: Extreme temperature resistance plastic surfaces -20° to +140°C!

The right trolley for every job

base-line
by DENIOS



Version Design	Pro			Tool		Service Sides open
	Sides open	Enclosed on 3 sides	Enclosed on 3 sides	2 drawers	1 drawer	
Number of levels	2	3	3	2	3	3
Overall load capacity [kg]	160	240	240	160	240	120
Platform dimensions W x D [mm]	450 x 680					350 x 480
External dimensions W x D x H [mm]	480 x 850 x 950	480 x 850 x 1000	480 x 850 x 1000	480 x 850 x 950	480 x 850 x 1000	370 x 650 x 900
Shelf height [mm]	180 / 820 /	180 / 520 / 860	180 / 520 / 860	180 / 820 /	180 / 520 / 860	140 / 460 / 780
Ø wheel [mm]	100					75
Order number	180-037-JB	180-038-JB	180-041-JB	180-039-JB	180-040-JB	180-042-JB



Steel transport trolley DENIOS base-line

Ideal for transporting small containers internally

- With adhesive anti-slip layer and all round guard strip, powder coated in blue
- Blue-grey smooth running solid rubber tyres, 2 swivel castors and 2 fixed castors



Alu transport trolley DENIOS base-line



Available immediately!

With lightweight, aluminium platform

- The collapsible handle saves storage space
- Platform with anti-slip surface and corner protectors



base-line
by DENIOS

DENIOS base-line - cost-effective, reliable transport trolley with useful features, universal use in many operational areas

	1	2	3	4
Material	Steel			Aluminium
Platform dimensions W x D [mm]	480 x 740	610 x 910	480 x 740	470 x 645
Number of levels	1	1	3	1
Features	1 folding handle		2 handles	1 folding handle
Overall load capacity [kg]	150	250	120	150
External dimensions W x D x H [mm]	480 x 740 x 860	610 x 910 x 860	480 x 740 x 860	470 x 750 x 980
Ø wheel [mm]	100	125	100	100
Weight [kg]	15	20	26	10
Order number	157-604-JB	157-605-JB	157-607-JB	164-407-JB

DENIOS classic-line transport equipment

Reliable, everyday transport equipment at a fair price and with smart accessories e.g.:

- Sturdy design, impact and scratch resistant powder coating
- Smooth running TPE tyres with groove ball bearings, 2 swivel and 2 fixed castors with foot guard
- ErgoStop central brake - Quick and easy operation of the pedal, even when wearing safety shoes, works immediately on both swivel castors.

classic-line
by DENIOS ■■



Light duty platform trolley DENIOS classic-line

Optimum price & performance

- Compact transport trolley for universal use
- Sturdy, ergonomic handle
- Anti-slip, sealed loading surfaces - available in 2 dimensions
- With either fixed or folding handle

classic-line
by DENIOS ■■



Folding handle with simple foot operation - perfect for transport or when there is a space restriction



Model Platform dimensions W x D [mm]	Light duty platform trolley			
	450 x 850	600 x 1000	450 x 720	600 x 900
Design	Fixed handle		Folding handle	
Overall load capacity [kg]	200		150	250
Wheel diameter [mm]	125			160
Order number	258-199-JB	258-200-JB	258-202-JB	258-203-JB

Heavy duty platform trolley DENIOS classic-line

With a high load capacity for industrial use

- Ideally suited to easy transport of heavy goods
- Sturdy, ergonomic handle
- Anti-slip, sealed loading surfaces - available in 4 dimensions

classic-line
by DENIOS ■■



Model Platform dimensions W x D [mm]	Heavy duty platform trolleys			
	500 x 880	600 x 1030	700 x 1030	800 x 1230
Design	Fixed handle			
Overall load capacity [kg]	400		500	
Wheel diameter [mm]	160			200
Order number	258-213-JB	258-214-JB	258-212-JB	258-215-JB

Light duty workshop trolley DENIOS classic-line

The professional product for internal transport

- Anti-slip, sealed loading surfaces with edge
- Available with 2 or 3 shelves, each in 2 dimensions
- Either with space-saving straight or ergonomic high transport handle

classic-line
by DENIOS ■■

Especially comfortable to hold thanks to high handle



The straight handle makes transport easy, even for bulky loads

Model	Light duty workshop trolleys			
	2		3	
Number of levels	2		3	
Platform dimensions W x D [mm]	490 x 835	590 x 985	490 x 835	590 x 985
Overall load capacity/shelf [kg]	250 / 80			
Wheel diameter [mm]	125			
Order number High handle	258-174-JB	258-175-JB	258-187-JB	258-186-JB
Order number Straight handle	258-209-JB	258-208-JB	258-211-JB	258-210-JB

Heavy duty workshop trolley DENIOS classic-line

Load capacity up to 500 kg - for industrial use

- Ergonomic handle for easy transport
- Anti-slip, sealed loading surfaces
- Available in 4 loading surface dimensions

classic-line
by DENIOS ■■



ErgoStop central brake:
Safe, quick braking in any wheel position.

Model	Heavy duty workshop trolleys			
	2			
Number of levels	2			
Platform dimensions W x D [mm]	500 x 850	600 x 1000	700 x 1000	800 x 1200
Overall load capacity/shelf [kg]	400 / 200	500 / 200		
Wheel diameter [mm]	160		200	
Order number	258-196-JB	258-197-JB	258-198-JB	258-195-JB

Workshop trolley DENIOS classic-line, with steel spill trays

With watertight spill pallet for safe working

- Sturdy tubular steel design, impact and scratch resistant powder coated
- With oil-tight steel spill tray, edge height 40 mm, with either 2 or 3 shelves
- Smooth running TPE tyres with groove ball bearings, 2 swivel and 2 fixed castors with foot guard, ErgoStop central braking
- Ergonomic working height, sturdy handle for easy transport
- Optional design with grid and drain tap or with removable spill pallet
- Upper spill tray with grid and 1/4" drain tap, H 100 mm
- Edge height of lower spill tray: 25 mm

classic-line
by DENIOS ■■



Workshop trolley with steel spill trays and practical ErgoStop central brake



- Removable sheet steel spill tray at the top, with 2 handles, H 200 mm
- Edge height of lower spill tray: 25 mm



Model	Workshop trolley with steel spill trays				
	2		3		3
Number of spill pallets					
Platform dimensions W x D [mm]	495 x 845	695 x 995	595 x 995	595 x 995	495 x 845
Additional equipment	-	-	Grid, drain tap	Removable spill pallet	-
Overall load capacity/shelf [kg]	400 / 100		250 / 80		500 / 100
Wheel diameter [mm]	160	200	125		160
Order number	258-220-JB	258-221-JB	258-226-JB	258-876-JB	258-222-JB



Workshop trolley DENIOS classic-line, with plastic spill trays

Ideal for transporting e.g. hazardous substances in small containers

- Workshop trolley in steel with 2 removable spill trays in chemical-resistant polyethylene
- 2 handles and 2 swivel castors and fixed castors in polypropylene (Ø 100 mm), for easy, safe manoeuvring

classic-line
by DENIOS ■■



Model	Workshop trolley with plastic spill trays
Containment volume [L]	2 x 30
External dimensions W x D x H [mm]*	1041 x 660 x 920
Overall load capacity [kg]	170
Grid	without
Order number	115-214-JB

*Overall height including handle

Transport trolley DENIOS classic-line, with plastic spill pallet

Compact size: easy, safe manoeuvring even in confined spaces and passages

- Sturdy steel trolley with removable spill pallet in chemical-resistant polyethylene
- Ideal for transporting e.g. hazardous substances in small containers
- With handle and 2 fixed and 2 swivel castors, easy to manoeuvre, in polypropylene (Ø 100 mm)
- Either without or with grid in galvanised steel or plastic

classic-line
by DENIOS ■■



Model	Transport trolley with plastic spill tray		
Containment volume [L]	1 x 30		
External dimensions W x D x H [mm]*	1110 x 602 x 1074		
Overall load capacity [kg]	150		
Grid	without	galvanized	plastic
Order number	114-837-JB	114-839-JB	114-841-JB

*Overall height including handle

Transport trolley, with galvanised grid as storage surface (alternatively also available with PE grid)

Tiered trolleys VARIOfit

Professional trolley for universal use - e.g. for distributing packets and materials

- Sturdy steel design
- Base and shelves in high quality MDF board, beech finish
- Smooth running tyres in thermoplastic rubber on plastic rims with precision groove ball bearings
- High-quality powder coating, RAL 5010, gentian blue
- 2 swivel castors with EasySTOP and 2 fixed castors
- Swivel castors with foot guards



Design	Open tiered trolley			Tiered trolleys mesh	
	850 x 500	1000 x 700	1200 x 800	1000 x 700	1200 x 800
Number of levels		5		4	
Overall load capacity/shelf [kg]	400 / 80	250 / 80		500 / 80	
External dimensions W x D x H [mm]	500 x 910 x 1530	700 x 1060 x 1530	800 x 1260 x 1530	725 x 1190 x 1820	825 x 1390 x 1820
Diameter, Roll [mm]		160		200	
Order number	272-690-JB	272-691-JB	272-692-JB	272-693-JB	272-694-JB

Occasional trolleys VARIOfit, with open frame

Practical aid for quick and easy access to materials

- Sturdy tubular steel design, professional
- Available as fixed and tiltable versions
- Smooth running tyres in thermoplastic rubber on plastic rims with precision groove ball bearings
- High-quality powder coating, RAL 5010, gentian blue
- 2 swivel castors with EasySTOP and 2 fixed castors
- Swivel castors with foot guards



Suitable Euro standard available as accessories!

Model	Occasional trolley	
	Fixed shelves	Tiltable shelves
Design		
Maximum load [kg]	200	
Load [kg]	50	
External dimensions W x D x H [mm]	455 x 815 x 1185	
Order number	272-643-JB	272-644-JB

Box trolley VARIOfit, with 2-wing door

Lockable box trolley in high quality industrial finish

- Sturdy steel design
- Lockable 2-wing door with espagnolette lock, handle and cylinder lock
- Smooth running tyres in thermoplastic rubber on plastic rims with precision groove ball bearings
- High-quality powder coating, RAL 5010, gentian blue
- 2 swivel castors with EasySTOP and 2 fixed castors
- Swivel castors with foot guards



Design	Box trolley wire mesh		Box trolleys sheet metal	
Platform dimensions W x D [mm]	1045 x 685	1245 x 785	1045 x 685	1245 x 785
Overall load capacity/shelf [kg]		500 / 80		
Diameter, Roll [mm]		200		
Order number Number of levels: 3	272-681-JB	272-682-JB	272-685-JB	272-686-JB
Order number Number of levels: 5	272-683-JB	272-684-JB	272-687-JB	272-688-JB

Shelf trolleys VARIOfit, with variable shelves

Ideal for carrying larger quantities of materials

- Sturdy steel design
- Open or with tilting shelves, up to 17° or 32°
- Smooth running tyres in thermoplastic rubber on plastic rims with precision groove ball bearings
- High-quality powder coating, RAL 5010, gentian blue
- 2 swivel castors with EasySTOP and 2 fixed castors
- Swivel castors with foot guards



Model	Euro box trolley		Tiered trolleys		
External dimensions W x D x H [mm]	665 x 935 x 1125	650 x 1805 x 1275	650 x 1805 x 1575	550 x 1510 x 1815	650 x 1805 x 1855
Overall load capacity [kg]	200	400		250	400
Load [kg]	50		80		
Diameter, Roll [mm]	125	200		160	200
Order number Number of levels: 3	272-647-JB	272-648-JB	272-649-JB	-	-
Order number Number of levels: 4	-	-	-	272-650-JB	272-651-JB



The innovative Swedish manufacturer KONGAMEK has developed a range of practical, well-designed transport equipment. Here you'll find a selection of products for seamless in-house transport.



Workshop trolley KM Ergo in steel, with 2 MDF shelves

Attractive workshop trolley with a total load capacity of 1200 kg

- High quality powder coating, W x D: 680 x 1200 mm
- Easy to manoeuvre thanks to ergonomic handle
- Smooth-running, 2 fixed and 2 swivel castors (with brakes) in PA / rubber, precision bearings

Order no. 267-576-JB

Gas cylinder trolley KM Ergo

Ergonomic gas cylinder trolley for effortless changing of gas cylinders

- Simple to use, no heavy lifting - see video
- Electrogalvanised
- For 1 gas cylinder x 50 litres (max. Ø 235 mm)



Order no. 255-319-JB

Pallet trolley KM for Euro pallets

Welded chassis for Euro pallets 1200x800, with pallet retainer.

- Version with height adjustable platform: 655 - 835 mm, load capacity 800 kg
- Electrogalvanised for excellent corrosion protection
- 2 fixed and 2 swivel castors (with brakes) in solid rubber

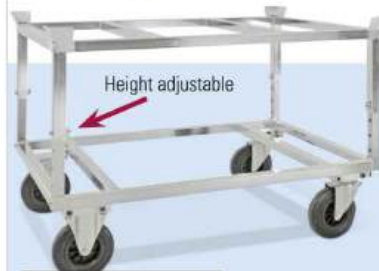

Height adjustable

Order no. 255-369-JB

Narrow workshop and platform trolleys KM

Highly versatile with 4 swivel castors, 2 with brakes.

- Electrogalvanised, load capacity 150 kg
- 2 melamine coated shelves, plastic coated handle for secure grip



Narrow transport trolley KM, shelves in white

Order no. 255-334-JB

Narrow transport trolley KM, shelves in red

Order no. 255-335-JB

KM Scooter, with footbrake

Easy to use scooter for safe, fast transport between workstations.

- Rubberised handle for ergonomic grip, foot plate with anti-slip surface for safe standing
- 3 wheels with puncture-proof tyres



Order no. 255-373-JB

Stainless steel trolley KM, with folding handle

Multipurpose, versatile platform trolley in stainless steel

- Platform W x D: 520 x 825 mm, load capacity 100 kg
- Folding handle for space-saving storage



Order no. 255-348-JB



General purpose trolley KM Ergo, with optimum height adjustment

Upper shelf has automatic height adjustment to the ideal working height when loading or unloading, adjustable in 5 steps for loads up to 90 kg

- Galvanised and coated with clear varnish for outstanding corrosion protection
- 4 smooth running swivel castors in grey TPR, precision bearings, 2 swivel castors with brakes

TOP PRODUCT



Order no. 267-577-JB

Stable long materials trolleys KM

Ideal for long goods such as pipes, easy to move even when heavily loaded.

- Length adjustable to 2500, 3500 and 4000 mm
- With 4 corner posts, handle and coupling eye, load capacity 3500 kg
- Pneumatic tyres, Ø 540 mm

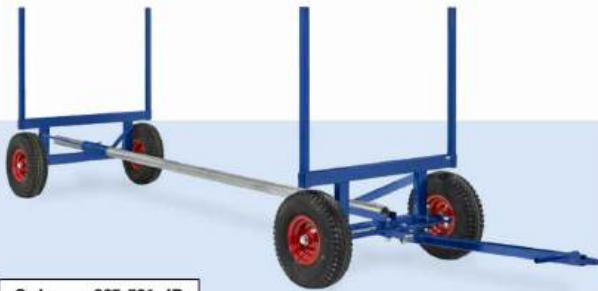

Order no. 267-581-JB

ESD tiered trolley KM, with 2 height adjustable shelves

Multipurpose, tested trolley for use in ESD areas, e.g. for protection when transporting or storing electrical components

- Electrically galvanised, with conductive mats and shelves, W x D: 470 x 945 mm, load capacity 250 kg
- W x D x H: 470 x 945 x 1120 mm, load capacity: 250 kg
- 4 swivel castors in electrically conductive solid rubber



Order no. 267-582-JB

Cleaning trolley KM Heavy Duty

Sturdy cleaning trolley for everyday use indoors and outdoors in workshops, warehouses, production, car parks etc.

- Large pneumatic tyres on steel rims for a smooth ride
- Practical holders for the safe attachment of brooms, shovels, waste sacks, gloves etc.
- Easy to manoeuvre thanks to ergonomic handle



Order no. 267-578-JB

Stable heavy duty trolleys KM

Equipped with handle with coupling eye and parking brake

- Powder coated tubular frame, plywood floor, W x D: 1000 x 2000 mm
- Load capacity: 750 kg dynamic, 1500 kg static
- Pneumatic tyres, Ø 400 mm



Order no. 267-580-JB

Roll box pallet in steel, Euro dimensions

Heavy duty container makes the ideal transport logistics solution for your business

- Sturdy tubular steel design with square tube frame, wire mesh 50 x 50 mm, galvanised blue
- 4 swivel castors in grey, smooth running rubber, 2 x brakes
- Also available as a large version (1350 x 950 mm) for use with Euro pallets

Optionally as an anti-theft container, closed on all sides with roof:

- For protection against unauthorised access

Intermediate shelf, see accessories



External dimensions W x D [mm]	Open on 2 sides		Open on 1 sides		Closed		Closed, with top
	1200 x 800	1200 x 800	1350 x 950	1200 x 800	1350 x 950	1350 x 950	
Features	2 doors, device for padlock						
Height [mm]	1820	1820	1820	1820	1820	1820	
Overall load capacity [kg]	600	600	800	600	800	800	
Ø roll [mm]	125	125	125	125	125	125	
Order number	266-078-JB	266-079-JB	266-088-JB	266-081-JB	266-089-JB	266-090-JB	
Order number Mesh intermediate shelf, 20 mm edge, slanted attachment	266-085-JB	266-085-JB	-	266-085-JB	-	-	
Order number Mesh intermediate shelf, variable attachment	266-083-JB	266-083-JB	266-091-JB	266-083-JB	266-091-JB	266-091-JB	

Stackable roll box pallet

Simple, quick to nest container - ideal for transport when empty and space saving storage

- Sturdy steel tube design, galvanised blue
- Gas-assisted folding lid, either in steel or plastic
- Castors Ø 108 mm. 2 swivel and 2 fixed castors in polyamide
- Sturdy steel tube design, galvanised blue

Optionally as an anti-theft container, closed on all sides with roof:

- Lockable door (padlock not included in the delivery)
- Wire mesh 50 x 50 mm, plastic top to provide rain protection



Order no. 266-105-JB

Order no. 266-098-JB

Nestable roll box pallet, saves space when nested inside each other

Features	Open on 2 sides		Open on 1 sides	Closed		Closed, with top
	Steel shelf	Steel shelf	Plastic shelf, 2 plastic intermediate shelves	Steel shelf, per 1 door, rear and front wall, CT closure	Steel shelf, 1 steel intermediate shelf, 1 door, CT closure	Plastic shelf, 1 plastic intermediate shelf, 1 door
External dimensions W x D [mm]	700 x 800	700 x 800	729 x 818	700 x 800	729 x 818	728 x 823
Height [mm]	1665	1665	1770	1665	1660	1880
Overall load capacity [kg]	500	500	500	500	500	500
Diameter, Roll [mm]	108	108	125	108	125	125
Order number	266-096-JB	266-097-JB	266-105-JB	266-098-JB	266-099-JB	266-108-JB



Logistics boxes Classic

Proven Roll holder with patented clamp technology



Logistics box model CL 2, open on 2 sides



Logistics box model CL 3, 2 side walls and 1 rear wall. (Shelf and rubber strap for transport safety available as an accessory)



Logistics box model CL 4, closed design with folding door

DENIOS ONLINE SHOP



Other versions (other sizes, door options and accessories) can be found in the Online Shop!

>> www.denios.co.uk/kat/12754 <<

- Dimensions to suit truck standard
- Sturdy Ø 22 mm tubular construction
- Zinc-plated
- Can be used from +60° C to -20° c
- Distance between shelves 300 mm
- 2 swivel castors, 2 fixed castors, Ø 108 mm, plastic wheels

	Open on 2 sides	Open on 1 sides	Closed
Platform dimensions W x D [mm]	680 x 815	680 x 775	660 x 745
Height [mm]	1660	1660	1660
Overall load capacity [kg]	500	500	500
Order number Without wheel brake	172-200-JB	172-202-JB	172-118-JB
Order number With wheel brake	172-201-JB	172-203-JB	172-204-JB
Accessories	Shelf (load capacity 150 kg), max. 4 Shelves per trolley		
Order number	268-074-JB	268-073-JB	172-121-JB

Roll box pallet with plastic base

Classic roll box pallet with narrow mesh walls

- 2 swivel and 2 fixed castors in polypropylene (brakes extra, see Shop for cost)
- Sturdy tubular steel design on rolling base, gentian blue, wire mesh 50 x 50 mm, galvanised blue

Optionally as an anti-theft container, closed on all sides with roof:

- Lockable door (padlock not included in the delivery)
- 1 folding intermediate shelf, fixed
- Also available on a steel roller base with 2-part door



	Open on 1 sides	Closed	Closed, with top	
Features	Plastic plate	Plastic plate, 1-part door	Plastic plate, 2-part door, intermediate shelf	Steel plate, 2-part door, intermediate shelf
External dimensions W x D [mm]	724 x 815	724 x 815	724 x 815	710 x 800
Height [mm]	1210	1550	1800	1790
Overall load capacity [kg]	500	500	500	500
Ø roll [mm]	108	108	108	108
Order number	266-050-JB	266-052-JB	266-057-JB	266-064-JB
Accessories				Order number
Rubber strap (for open version)				172-120-JB
Rubber tension strap, 1 wire hook / 1 wire loop				266-067-JB

Pallet truck Basic BR

- Economical, versatile model
- The wheels are manufactured from nylon
- The rear wheels are manufactured from polyurethane
- The pallet trucks are extremely flexible as they can be used on all surfaces
- Quiet operation

Model	BR 2	BR 4
Overall load capacity [kg]	2200	
Number of load rollers	2	4
Fork length [mm]	1150	
Supporting width [mm]	525	
Overall length [mm]	1550	
Lift height max [mm]	200	
Order number	128-383-JB	128-384-JB

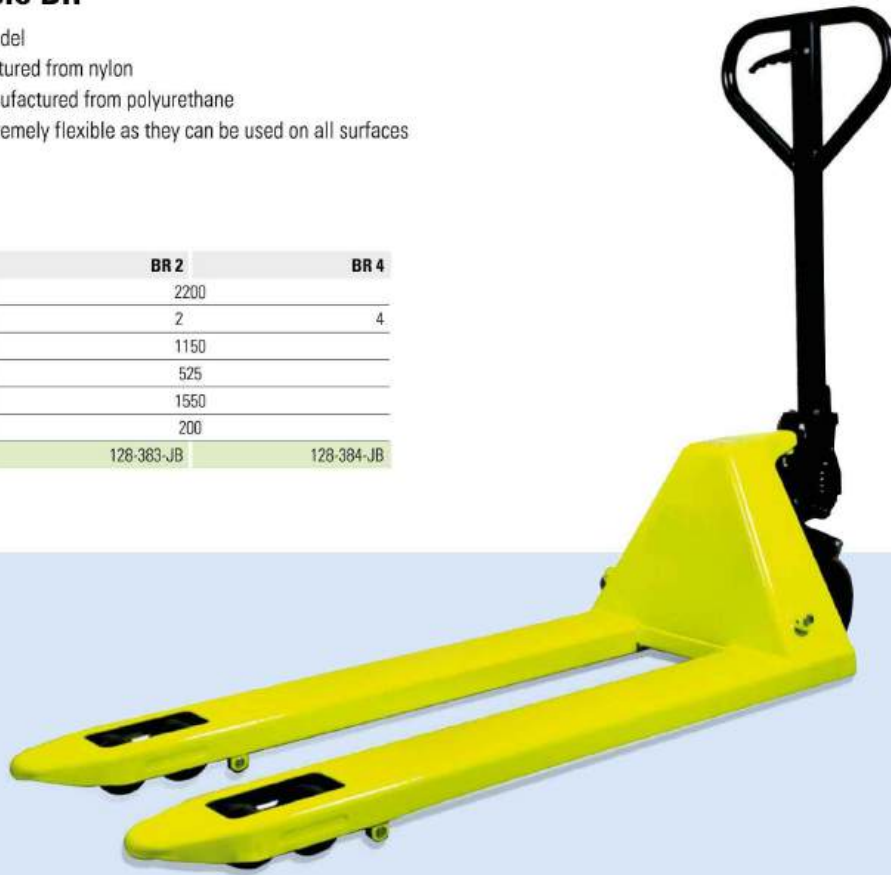

Pallet truck Pro PR

- For heavy duty, industrial usage
- The high load capacity of 2500 kg ensures use in most applications
- The wheels are manufactured from hard wearing nylon
- The pallet trucks are extremely flexible as they can be used on all surfaces
- Quiet operation



Model	PR 2	PR 4
Overall load capacity [kg]	2500	
Number of load rollers	2	4
Fork length [mm]	1150	
Supporting width [mm]	525	
Overall length [mm]	1550	
Lift height max [mm]	200	
Order number	128-385-JB	128-386-JB





Pallet truck with scales Model HW

Combine the comfort of a pallet truck with the functionality of a drum transport and lifting trolley

- Ideal combination for lifting and weighing in one unit
- Extremely sturdy - ideal for heavy duty and industrial use
- Scales and display built in to protective steel housing
- Functions: tare, zero, addition function for weighing, counting reference parts etc
- Weight range 1 to 2200 kg in 1 kg steps



Detail: scales with large LCD display (30 mm) for easy-to-read data

Tandem driving wheels in polyurethane



Pallet truck HW with integrated scales

Order no. 128-380-JB

Rubber swivel castors

Drum lifting truck for 205 litre steel drums

For straightforward lifting, placing and transporting of a 200 litre steel drum on level ground

- Combine the comfort of a pallet truck with the functionality of a drum transport and lifting trolley
- For straightforward lifting, placing and transporting of a 200 litre steel drum on level ground
- Load capacity: 350 kg
- The clamp opens when lowered and picks up the drum
- Wheels manufactured from nylon



Drum lifting truck for 205 litre steel drums, load capacity 350 kg

Order no. 158-052-JB



High lift pallet truck

- The frame and forks are distortion resistant
- Features a safety handle with A 3 way function: lifting/ lowering/transporting, which can be operated using one hand
- Stabilising bars lock into place as the truck lifts to the right position for loading /unloading
- Battery operated unit with charger
- Electrohydraulic pump set 12 V
- Lifting motor 12 V
- Charger 12 V / 10 a with automatic switch off
- Lifting height range: from 85-800 mm
- Load capacity: 1000 kg
- Fork L x W: 1165 x 160 mm
- Supporting width: 540 mm
- Swivel wheels Ø x B: 200 x 50 mm, polyurethane
- Fork castors Ø: 80 mm, polyurethane



High lift pallet truck SHW E
Design with electro hydraulics

Order no. 128-382-JB



Scissor lifting table



Optimum ergonomic loading and unloading for pallet goods

- Profiled steel/ steel sheet design
- Powder-coated in blue (RAL 5007)
- Sturdy pushbar - with a protective plate to prevent slipping through
- Hydraulic pump with chrome plated pistons
- Operated via a foot pedal

- Valve to lower platform operated by handle
- 2 swivel and 2 fixed castors, wheels with polyurethane tyres, swivel castors with brake in accordance with EN 1570

Single scissor lift table

- 1** Load capacity: 150 kg
- 2** Load capacity: 250 kg
- 3** Load capacity: 500 kg

With collapsible handle



1



- 4** Load capacity: 300 kg
- 5** Load capacity: 500 kg

Double scissor lift table

Mobile lifting table

Load capacity: 900 kg

- Profile steel / steel sheet design with rounded platform
- 4 telescope pillars ensure a stable footing

- Raising and lowering via 2 separate foot pedals
- Handle
- Powder-coated in blue (RAL 5010)
- Each with 2 swivel and fixed polyurethane wheels
- Available in 2 sizes



Locking devices with lowerable support ensure secure standing. (Can be released again with light foot pressure)

6 7

1 2 3 4 5 6 7

Platform dimensions W x D [mm]	Single scissor lift table			Double scissor lift table		Mobile lifting table	
	450 x 700	500 x 830	520 x 1010	520 x 1010	520 x 1010	610 x 915	815 x 1220
Overall load capacity [kg]	150	250	500	300	500	900	900
Lift height max [mm]	755	910	1000	1585	1575	1220	1220
Lift height min [mm]	265	330	435	435	440	760	760
External dimensions W x D [mm]	450 x 950	500 x 1010	520 x 1185	520 x 1260	520 x 1260	610 x 915	815 x 1220
Ø wheel [mm]	100	125	150	150	150	100	100
Order number	157-623-JB	157-624-JB	157-625-JB	157-628-JB	157-629-JB	180-035-JB	180-036-JB

Crane arms, various versions

Available as rigid version, extendable version and extendable as well as height-adjustable version

- The crane arm converts the forklift into a practical crane for medium to heavy loads
- The reach of the forklift is significantly extended
- For lifting loads which cannot be picked up from underneath by the forklift blades
- Excellent aid when goods need to be lifted over a barrier for example or when removing or refitting machine components
- Safety first: chain protection against slipping off the forklift blades
- The crane arms are available in the following versions: rigid, extendable, extendable and height adjustable

Available in 7 colours



Crane arm, extendable version (6 extension positions)

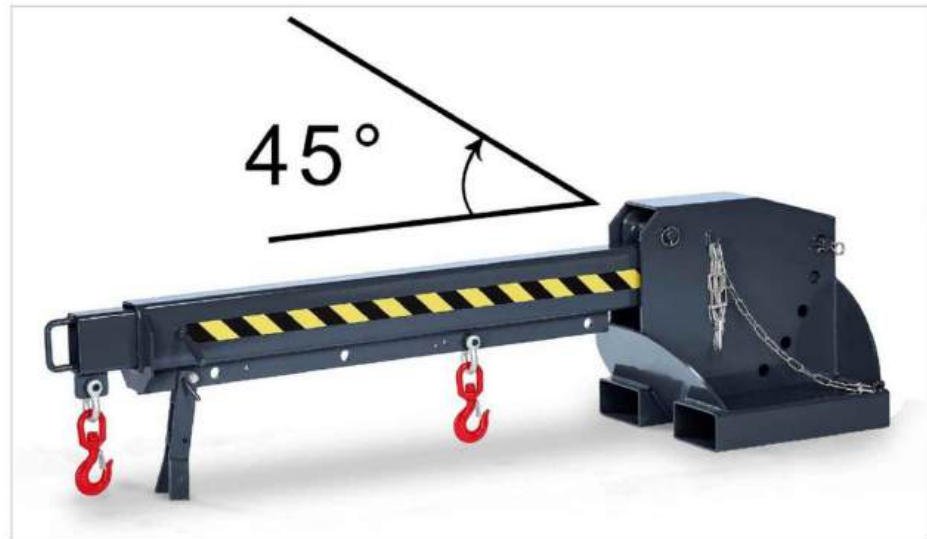

Crane arm, extendable and height-adjustable version (6 extension positions, 5 height adjustments up to 45°)

Design	Pull-out version	Pull-out and height adjustable version	Pull-out version	Pull-out and height adjustable version	
Maximum load [kg]	3000		5000		8000
Jib length II [mm] / Max. load capacity [kg]*	3600 / 650		3600 / 1000		3600 / 1250
Forklift pocket W x H [mm]			188 x 88		
Distance between fork pockets [mm]	102	169	102	169	193
Blue					
Order number	145-446-JB	145-447-JB	276-446-JB	276-460-JB	276-468-JB
Anthracite					
Order number	276-445-JB	276-459-JB	276-452-JB	276-466-JB	276-474-JB

*Max. Load capacity for fully extended crane arm



Load arms, various versions



Available as rigid version, extendable version with 25° incline and telescopic version with 25° incline

- The load arm converts the forklift into a practical crane for low to medium loads
- The reach of the forklift is extended
- For lifting loads which cannot be picked up from underneath by the forklift blades

- Excellent aid when goods need to be lifted over a barrier for example or when removing or refitting machine components
- Safety first: chain protection against slipping off the forklift blades

Available in 6 colours

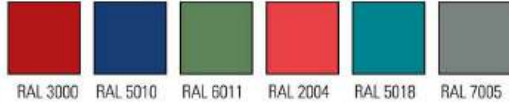

RAL 3000 RAL 5010 RAL 6011 RAL 2004 RAL 5018 RAL 7005

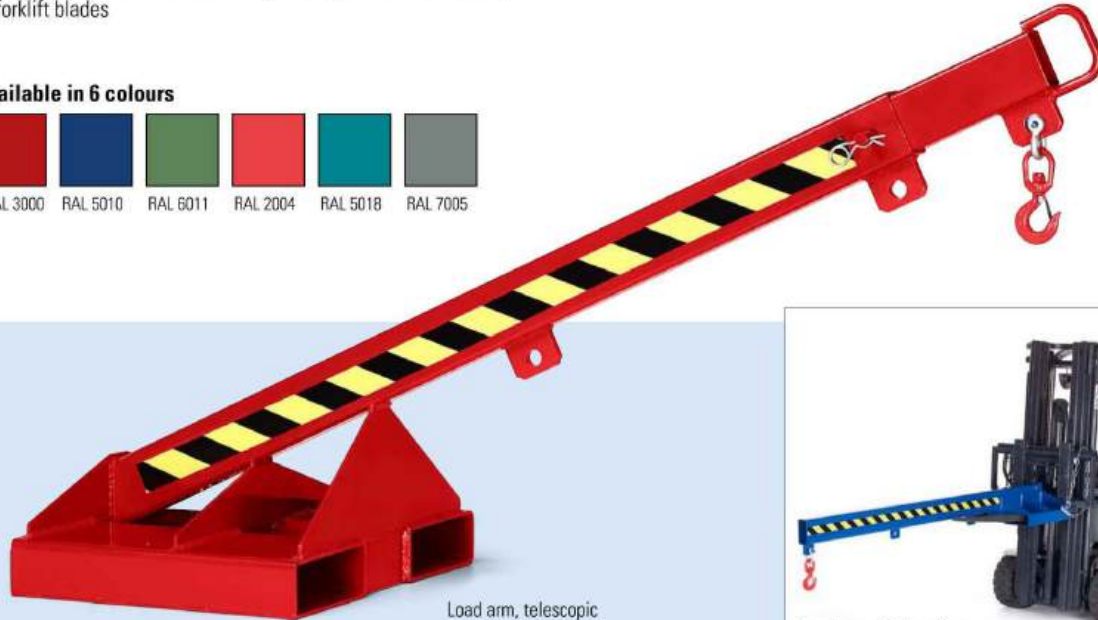

Load arm, telescopic version with 25° angle



Load arm, rigid version

Design	Rigid version						Rigid version, with 25° angle	Telescopic version, with 25° angle
Maximum load [kg]	1000		2500		5000		1000	
Jib length II (mm) / Max. load capacity [kg]*	1450 / 250	2350 / 100	1450 / 550	2350 / 250	1450 / 1050	2350 / 500	1345 / 350	2270 / 175
Forklift pocket W x H [mm]							220 x 77	
Distance between fork pockets [mm]							160	
Blue								
Order number	276-384-JB	276-391-JB	276-398-JB	276-405-JB	276-412-JB	276-419-JB	276-426-JB	276-433-JB
Red								
Order number	276-385-JB	276-392-JB	276-399-JB	276-406-JB	276-413-JB	276-420-JB	276-427-JB	276-434-JB

*Max. Load capacity for fully extended crane arm

Fork lift extensions



If the length of the forklift blades is not sufficient for transport, fork extensions are a quick, cost-effective solution. The closed box profile tapers at the front and underneath so that the attachment can be used to pick up pallets from below.

- Practical fork extension made of 6 mm sheet steel with closed bottom
- For the transport of large-volume goods
- Safety first: secured against slipping with locking pins
- The fork extension must rest at least 60% on the forks of the truck
- The prices quoted are per pair
- Available in the following lengths [mm]: 1600, 1800, 2000, 2200, 2400, 2600, 2800, 3000
- Available for the following forklift blade dimensions [mm]: 80x40, 100x40, 100x45, 100x50, 120x40, 120x50, 125x45, 125x50, 150x50



Suitable tine dimension WxH [mm]	Fork lift extensions		
	120 x 40	125 x 50	150 x 50
Fork length [mm]: 1600			
Order number	276-315-JB	276-318-JB	276-319-JB
Fork length [mm]: 1800			
Order number	276-324-JB	276-327-JB	276-328-JB
Fork length [mm]: 2000			
Order number	276-333-JB	276-336-JB	276-337-JB
Fork length [mm]: 2200			
Order number	276-342-JB	276-345-JB	276-346-JB
Fork length [mm]: 2400			
Order number	276-351-JB	276-354-JB	276-355-JB
Fork length [mm]: 2600			
Order number	276-360-JB	276-363-JB	276-364-JB

Tipping skips and tipping containers PolySkip

Particularly stable, seamlessly manufactured tipping skips and containers in weather-resistant plastic (PE). These containers are also leakproof and are therefore suitable for collecting materials that may leak fluid.

- Large capacity containers for provision of small parts or separate collection of waste and recyclable materials
- Corrosion-free, weather-resistant polyethylene (PE)
- Easy to clean



Tipping skips and containers, PolySkip from 300 to 1000 litres



Tipping skip PolySkip, with castors

PolySkip tipping skip

- Watertight
- For manual transport of waste and recyclable materials, for example to a central collection point
- Easy to move due to large castors (Ø 200 mm) and swivel castors (Ø 125 mm) of polyamide, lockable
- The skip can be emptied by manually tipping the container over the axle of the wheels into a ditch or a low basin etc
- Optionally available with 2-part folding lid in PE (grey)

ORDER AT THE SAME TIME

Pictogram set

- For recyclable material containers and refuse bin boxes
- Pictogram set with symbols: paper, plastics, residual waste, glass, sheet metal/metal and bio-waste
- Waterproof and self adhesive
- Format (H x W): 180 x 160 mm

Order no. 154-062-JB



2 part PE lid, grey

Available in 3 colours



Capacity [l]	300	500	750	1000
Features	2 swivel castors, 2 fixed castors	2 swivel castors, 2 fixed castors	2 swivel castors, 2 fixed castors	2 swivel castors, 2 fixed castors
External dimensions W x D x H [mm]	920 x 1320 x 625	960 x 1440 x 825	1145 x 1560 x 925	1173 x 1586 x 1095
Bulk goods edge height [mm]	405	460	560	670
Overall load capacity [kg]	150	150	250	250
Weight [kg]	30	38	44	49
Order number Blue	148-372-JB	136-459-JB	136-460-JB	181-684-JB
Order number Grey	153-536-JB	153-540-JB	153-566-JB	181-687-JB
Order number Red	153-535-JB	153-539-JB	153-563-JB	181-686-JB
Accessories	2 part PE lid, grey			
Order number	185-837-JB	185-838-JB	185-839-JB	185-840-JB



PolySkip tipping skip

- Watertight
- With forklift pockets
- Release via cable pull from the driver's seat
- With integrated spring scissor mechanism for limiting the tilting process and to protect the container against damage
- Optionally available with 2-part folding lid in PE (grey)



Tipping skip PolySkip, with forklift pockets



Tipping skip PolySkip, with forklift pockets and castors

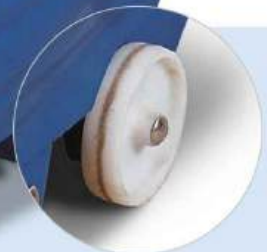

Polyamide castors

Available in 3 colours



Size of fork-lift truck pockets in mm

60	150	226 (for models with 200/500 lb capacity)	326 (for models with 750/1000 lb capacity)	150	60
----	-----	---	--	-----	----

Capacity	300	500	750	1000
Features	With forklift pockets and castors	With forklift pockets and castors	With forklift pockets and castors	With forklift pockets and castors
External dimensions W x D x H [mm]	920 x 1420 x 660	960 x 1530 x 830	1145 x 1650 x 925	1173 x 1660 x 1095
Bulk goods edge height [mm]	405	460	560	670
Overall load capacity [kg]	150	150	250	250
Weight [kg]	45	53	62	67
Order number Blue	148-379-JB	144-622-JB	144-623-JB	181-692-JB
Order number Grey	153-594-JB	153-599-JB	153-603-JB	181-695-JB
Order number Red	153-593-JB	153-597-JB	153-602-JB	181-694-JB
Accessories	2 part PE lid, grey			
Order number	185-837-JB	185-838-JB	185-839-JB	185-840-JB

Capacity [l]	300	500	750	1000
Features	With forklift pockets	With forklift pockets	With forklift pockets	With forklift pockets
External dimensions W x D x H [mm]	920 x 1420 x 625	960 x 1530 x 790	1145 x 1650 x 890	1173 x 1660 x 1060
Bulk goods edge height [mm]	370	420	520	635
Overall load capacity [kg]	150	150	250	250
Weight [kg]	43	50	59	64
Order number Blue	148-377-JB	136-449-JB	136-450-JB	181-688-JB
Order number Grey	153-572-JB	153-578-JB	153-591-JB	181-691-JB
Order number Red	153-571-JB	153-576-JB	153-590-JB	181-690-JB
Accessories	2 part PE lid, grey			
Order number	185-837-JB	185-838-JB	185-839-JB	185-840-JB

Tipping skip

For collecting and transporting bulk goods of any type

- Tipping skips in long lasting welded steel design with manual tipping container
- Metal thickness of the container 2 mm
- With forklift pockets (160 x 90 mm)
- With swivel and fixed castors in solid rubber (Ø 200 mm)
- Sturdy handle to enable manual operation

Capacity [l]	250	400	600
External dimensions W x D x H [mm]	895 x 1180 x 915	930 x 1440 x 1000	1040 x 1560 x 1125
Bulk goods edge height [mm]	825	910	1030
Forklift pocket W x H [mm]	160 x 90	160 x 90	160 x 90
Distance between fork pockets [mm]	360	400	510
Overall load capacity [kg]	600	600	600
Weight [kg]	60	85	110
Order number powder coated	145-021-JB	145-022-JB	145-023-JB
Order number Hot dip galvanised	145-024-JB	145-025-JB	145-026-JB
Accessories	2-part lid, galvanised		
Order number	195-522-JB	145-055-JB	145-055-JB

ORDER AT THE SAME TIME

Strainer insert and drain tap The strainer insert prevents coarse dirt from blocking the drain tap

Order no. 145-061-JB



Tipping skips with 250, 400 or 600 litre volume, load capacity 600 kg (all versions)

More colour options can be found in our online shop.

Tipping skip

For collecting and transporting bulk goods of any type

- Compact design, low height
- Study frame manufactured from u-channels, the tipping trough is manufactured from 3mm steel sheet with reinforcement at the edges
- With forklift pockets (200 x 70 mm) (min. Fork length 800 mm)
- With swivel and fixed castors in polyamide (Ø 175 mm)
- Sturdy handle to enable manual operation
- Release via cable pull from the forklift seat
- Easy tipping over the side
- Integrated control mechanism for limiting the tilting process and to protect the container against damage
- Additional chain protection to prevent slipping from the the forklift blades



Detailed illustration:
unlocking device and
forklift pockets

Capacity [l]	300	500	750	1000
External dimensions W x D x H [mm]	830 x 1350 x 810	1280 x 1350 x 810	1200 x 1640 x 1060	1580 x 1640 x 1060
Bulk goods edge height [mm]	700	700	925	925
Forklift pocket W x H [mm]	200 x 70	200 x 70	200 x 70	200 x 70
Distance between fork pockets [mm]	280	60	60	500
Overall load capacity [kg]	750	1000	1350	1350
Weight [kg]	115	140	175	205
Order number powder coated	145-027-JB	145-028-JB	145-029-JB	145-030-JB
Order number Hot dip galvanised	145-031-JB	145-032-JB	145-033-JB	145-034-JB
Accessories	2-part lid, galvanised			
Order number	195-522-JB	145-055-JB	145-055-JB	145-057-JB

ORDER AT THE SAME TIME

Strainer insert and drain tap The strainer insert prevents coarse dirt from blocking the drain tap

Order no. 145-061-JB



Tipping skip NB

- Low height
- For collecting and transporting bulk goods of any type
- Ideal as an occasional use container for a machine
- The body of the skip is manufactured from 3 mm steel sheet with circumferential reinforcement at the edges
- With forklift pockets
- Release via cable pull from the forklift seat
- Shock absorber device between the floor of the skip and the supporting frame enables easy emptying
- Additional chain protection to prevent slipping from the the forklift blades



Size of fork-lift truck pockets in mm

60	200	500 (for models with 50 t/c capacity)	200	60
		200 (for models with 300 / 500 t/c capacity)		

More colour options can be found in our online shop.



ORDER AT THE SAME TIME

Wheel set consisting of 2 fixed and 2 swivel castors (one with brake) manufactured from polyamide

For loads up to 1350 kg

Order no. 145-063-JB

For loads up to 2500 kg

Order no. 145-064-JB



The **2-part lid** (see table) protects the contents

Capacity [l]	300	500	750	1000	1250	1500
External dimensions W x D x H [mm]	680 x 1400 x 580	780 x 1400 x 680	1240 x 1520 x 800	1240 x 1620 x 800	1130 x 1570 x 980	1330 x 1570 x 980
Bulk goods edge height [mm]	500	600	700	600	730	730
Overall load capacity [kg]	900	1200	1500	1800	2000	2000
Weight [kg]	100	115	162	184	195	205
Order number powder coated	145-041-JB	145-042-JB	145-043-JB	145-044-JB	145-430-JB	145-045-JB
Order number Hot dip galvanised	145-046-JB	145-047-JB	145-048-JB	145-049-JB	145-431-JB	145-050-JB
Accessories	2-part lid, galvanised					
Order number	195-522-JB	145-055-JB	145-055-JB	145-057-JB	145-057-JB	145-057-JB

Bulk material containers

- For collecting and transporting solid substances or bulk goods
- Long-lasting steel frame and sheet steel construction
- Easy emptying - the bottom flap is opened by cable pull directly from the seat of the forklift truck
- Flap self-closes when touching the floor or the edge of the collection trough
- Bottom flap with large aperture angle to fully empty
- Forklift pockets for forklift access (W x H: 180 x 100 mm)

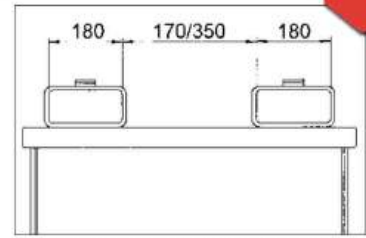

Forklift pockets dimensions (mm), 350 mm for 1000 litres



Example of usage: the base of the skip opens easily when the fork lift truck driver pulls the attached cable

Capacity [l]	500	750	1000
External dimensions W x D x H [mm]	900 x 1250 x 850	900 x 1250 x 1150	900 x 1650 x 1150
Overall load capacity [kg]	500	750	1000
Colour	Blue	Blue	Blue
Weight [kg]	125	152	178
Order number	163-424-JB	164-784-JB	164-787-JB

Tipping skips for shavings

- For collecting and transporting chips and other materials with fluid like adhesion
- Integrated collecting basin to collect residues from oil and coolants, for example. A ball valve enables the systematic emptying of the collection basin
- Long-lasting steel frame and sheet steel construction
- Easy emptying - the bottom flap is opened by cable pull directly from the seat of the forklift truck
- Flap self-closes when touching the floor or the edge of the collection trough
- Bottom flap with large aperture angle to fully empty
- Forklift pockets for forklift access (W x H: 180 x 100 mm)



Detailed illustration:
drain Tap

Capacity [l]	500	750	1000
External dimensions W x D x H [mm]	900 x 1250 x 850	900 x 1250 x 1150	900 x 1650 x 1150
Overall load capacity [kg]	500	750	1000
Colour	Red	Red	Red
Weight [kg]	125	155	180
Order number	164-887-JB	164-888-JB	164-889-JB



Compact tipper for shavings



- Effective separation of liquids and solids
- Welded, oil- and water-tight
- Low height
- Ideal as an occasional use container for a machine
- Equipped as standard with perforated metal raised floor and dispensing Tap
- The body of the skip is manufactured from 3 mm steel sheet with circumferential reinforcement at the edges
- The perforated metal floor can be removed for easy cleaning
- With forklift pockets
- Release via cable pull from the forklift seat
- Shock absorber device between the floor of the skip and the supporting frame enables easy emptying
- With chain protection to prevent the forklift blades from slipping
- 2 part galvanised lid and wheel set are available as an accessory

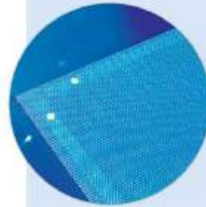

Detailed illustration: floor manufactured from perforated plate

Shavings compact tipper, available in different sizes (wheel set optional)

ORDER AT THE SAME TIME

Wheel Set consisting of 2 fixed and 2 swivel castors (one with brake) manufactured from polyamide

For loads up to 1350 kg

Order no. 145-063-JB

For loads up to 2500 kg

Order no. 145-064-JB

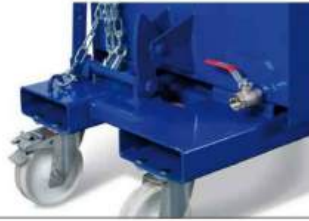

Detailed illustration: drain Tap



Size of fork-lift truck pockets in mm

60	200	500 (for models with 50 ltr capacity)	200 (for models with 300 / 500 ltr capacity)	200	60
----	-----	---------------------------------------	--	-----	----

More colour options can be found in our online shop.

Capacity [l]	300	500	750	1000	1250	1500
External dimensions W x D x H [mm]	680 x 1400 x 580	780 x 1400 x 680	1240 x 1520 x 800	1240 x 1620 x 800	1130 x 1570 x 980	1130 x 1570 x 980
Bulk goods edge height [mm]	500	600	700	600	730	730
Overall load capacity [kg]	900	1200	1500	1800	2000	2000
Weight [kg]	125	140	172	209	220	230
Order number	181-503-JB	181-504-JB	181-505-JB	181-506-JB	181-507-JB	181-508-JB
Accessories	2-part lid, galvanised					
Order number	195-522-JB	145-055-JB	145-055-JB	145-057-JB	145-057-JB	145-057-JB



Euro pallet cages, model PG

Optimal storage for pallets

- Welded steel tube design
- Can be stacked 4 high
- The sides are manufactured from steel mesh, size of mesh is 100 x 100 mm
- One side has a fold down flap
- Quick to fit
- Painted: blue (RAL 5012)



Model	PG 8	PG 10	PG 12	PG 16
External dimensions W x D x H [mm]	1200 x 800 x 800	1200 x 800 x 1000	1200 x 800 x 1200	1200 x 800 x 1600
Overall load capacity [kg]	1000	1000	750	750
Stackable	4 times	4 times	4 times	4 times
Weight [kg]	24.5	27.5	31.0	40.0
Order number	129-236-JB	129-237-JB	129-238-JB	129-239-JB



Stacking frames model PH for Euro pallets

Optimal storage for pallets

- Sturdy welded steel tube design
- With 2 stabilising tubes and 4 stacking corners
- Quick to fit
- Can be stacked 3 high
- Painted: blue (RAL 5012)



Model	PH 8	PH 10	PH 12	PH 16
External dimensions W x D x H [mm]	1200 x 800 x 800	1200 x 800 x 1000	1200 x 800 x 1200	1200 x 800 x 1600
Overall load capacity [kg]	1500	1500	750	750
Stackable	3 times	3 times	3 times	3 times
Weight [kg]	21.5	24.0	27.5	31.5
Order number	129-243-JB	129-244-JB	129-245-JB	129-246-JB

Stackable frame PH with 2 stabilising tubes and 4 stackable corners

Mesh box pallet turner

The mesh box is picked up from underneath on the long side. A lever is operated to secure it and arms grip the feet of the mesh box. The mesh box is tilted by releasing a winch. The mesh box returns to an upright position when the forklift is reversed. The Mesh box pallet turner can be secured to the forklift truck via a chain.



- For emptying Euro mesh boxes in accordance with UIC standard 435-3
- For turning mesh boxes using a forklift



Model	Mesh box pallet turner
External dimensions W x D x H [mm]	570 x 1640 x 450
Overall load capacity [kg]	450
Weight [kg]	90
Order number	145-437-JB



Euro mesh box exchange pallet

Ideal for storage and transport purposes

- Complies with international laws and regulations for transportation on goods vehicles by road and rail (in accordance with UIC standard 435-3)
- Front of the mesh box has two flaps and two boards
- 4 feet enable the mesh box to be picked up by a forklift from all 4 sides
- With stacking corners for stacking the mesh boxes
- Paint: stone grey (RAL 7030)
- Load capacity: 1500 kg

Mesh box pallet lid

- Plastic cover for protecting stored goods in a mesh box
- In impact resistant, seamless polyethylene (PE)
- The cover fits into the angled edge around the mesh box pallet
- The mesh box cover can be secured at the front with a padlock (available as an optional accessory)

ORDER AT THE SAME TIME

Padlock with chain

Order no. 114-900-JB



Euro mesh box exchange pallet (lid and spill pallet optional)

Order no. 129-203-JB



Mesh box pallet lid

Order no. 106-176-JB

Mesh box pallet covers

Practical accessories for Euro mesh boxes

- Protect stored goods from dirt and weather
- High-quality textile hood, tear and weather resistant
- Secure carabiner and bungee fastening
- Integral DIN A4 document pocket



Mesh box pallet cover, closed

Order no. 145-339-JB



Mesh box pallet cover, front side opens

Order no. 145-343-JB

Mesh box pallet inserts

These inserts enable you to extend the possibilities of the standard mesh box pallet to create a universally useable storage and logistics container

- For storage, collection, and loss-free transport of small packages, loose bulk goods etc
- Chemical-resistant polyethylene construction
- For all mesh boxes in accordance with UIC standard 435-3

Design	Closed	Without front panel
External dimensions W x D x H [mm]	1195 x 795 x 780	1195 x 795 x 780
Weight [kg]	11	11
Order number	145-341-JB	145-342-JB



Mesh box pallet insert without front panel

Order no. 145-342-JB



Mesh box pallet insert, closed

Order no. 145-341-JB

Mesh box cross bar

For lifting and transporting a mesh box

- Easy and safe handling of regulation compliant mesh box pallets
- Welded steel design with a crane eye
- Bracket lifts to assist hanging
- The low construction height allows the full capacity of the crane to be used
- Painted yellow (RAL 1004)

Mesh box cross member with 1000 kg load capacity

Order no. 129-204-JB

Mesh box cross member with 2000 kg load capacity

Order no. 129-205-JB



PE stackable containers PolyPro

- Space-saving collection and provision of your warehouse goods and recyclable materials
- In environmentally friendly polyethylene (PE)
- Corrosion free and durable
- Liquid-tight, can also be used as a spill pallet for water-polluting substances and can be stacked 2-high
- Stable with a low dead weight
- Easy to clean
- Easy to access by pallet truck or fork lift from front or sides
- Can be stacked 5 high, can also be stacked with steel stacking containers of the same dimensions
- Safe storage of containers for holding acids or alkalis, non-flammable cleaning solutions etc.



Available in 3 colours



PolyPro plastic stacking containers, in different sizes and designs

PE box inserts for PolyPro stacking containers

The PE box inserts were specially developed to bring an overview and order to PolyPro stacking containers. With ergonomic handles for easy insertion and removal. The PE box inserts are stackable. The matching box insert sizes can be combined within the same PolyPro stacking container size (see example).



Arrangement example

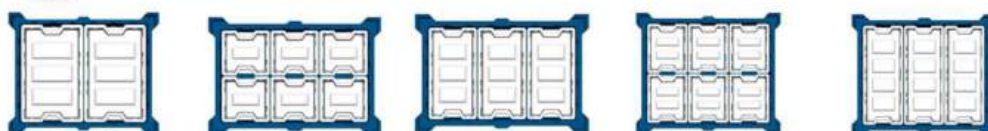

PE insert box, suitable for	PolyPro with 260 litre volume	PolyPro with 300 litre volume		PolyPro with 400 litre volume	
External dimensions W x D x H [mm]	437 x 685 x 440	351 x 331 x 440	351 x 667 x 440	351 x 430 x 440	351 x 865 x 440
Overall load capacity [kg]	100	40	80	50	100
Colour	Grey	Grey	Grey	Grey	Grey
Max. Number per stacking container	2	6	3	6	3
Order number	272-436-JB	272-437-JB	272-438-JB	272-439-JB	272-440-JB



Advantage - the stackable container with added value

- Useful, versatile container for your facilities

As Universal plastic container



As manoeuvrable container



The stacking PE containers can be easily transported indoors using a forklift or a pallet truck

The need for safe storage has been ideally combined here with the optimum transport options. High load capacity – with a permitted stacked load of max. 2.5 t, up to 5 stackable containers can be stacked safely.



Available in 3 colours



Capacity [l]	90	260	300	400
External dimensions W x D x H [mm]	800 x 500 x 500	1000 x 800 x 600	1200 x 800 x 600	1200 x 1000 x 600
Sump Volume [l]*	70	240	280	360
Overall load capacity [kg]	500	500	500	500
Stacked load [kg]	2500	2500	2500	2500
Access width (long side) [mm]	280	350	420	420
Access width (short side) [mm]	340	250	220	320
Order number	185-800-JB	185-805-JB	185-815-JB	185-825-JB

*When used as spill pallet

Multipurpose pallet boxes model PB 8 and PB 10

Sturdy polyethylene (PE) construction, with rounded internal corners

- Can be fully emptied and is easy to clean thanks to rounded internal corners
- Suitable for storing food
- Ideal for the storage and transport of a wide range of fillers
- Ideal for large quantities
- Accessible from all four sides
- Easy to stack
- Closed on 4 sides or available with a fold-down section on one long side
- Enclosed on 4 sides (watertight)



Collecting box model PB (lid optional)

ORDER AT THE SAME TIME



Lid for model PB 8

Order no. 117-884-JB

Lid for model PB 10

Order no. 117-889-JB



Model	PB 8-F	PB 8-FK	PB 8-K	PB 8-K	PB 8-R	PB 8-RK
Features	4 feet	4 feet	2 runners	3 runners	4 swivel castors	4 swivel castors
Version	–	Front flap	–	–	–	Front flap
Capacity [l]	535	535	330	535	535	535
External dimensions W x D x H [mm]	1200 x 800 x 760	1200 x 800 x 760	1200 x 800 x 600	1200 x 800 x 790	1200 x 800 x 915	1200 x 800 x 915
Internal dimensions W x D x H [mm]	1110 x 710 x 610	1110 x 710 x 610	1110 x 710 x 420	1110 x 710 x 610	1110 x 710 x 610	1110 x 710 x 610
Overall load capacity [kg]	500	500	470	500	500	500
Weight [kg]	35	35	33	41	47	47
Order number	117-880-JB	117-882-JB	217-096-JB	117-883-JB	117-881-JB	217-095-JB



Model	PB 10-F	PB 10-FK	PB 10-K	PB 10-K	PB 10-R	PB 10-RK
Features	4 feet	4 feet	2 runners	3 runners	4 swivel castors	4 swivel castors
Version	–	Front flap	–	–	–	Front flap
Capacity [l]	670	670	430	670	670	670
External dimensions W x D x H [mm]	1200 x 1000 x 760	1200 x 1000 x 760	1200 x 1000 x 600	1200 x 1000 x 790	1200 x 1000 x 915	1200 x 1000 x 915
Internal dimensions W x D x H [mm]	1110 x 910 x 610	1110 x 910 x 610	1110 x 910 x 420	1110 x 910 x 610	1110 x 910 x 610	1110 x 910 x 610
Overall load capacity [kg]	500	500	510	500	500	500
Weight [kg]	40	40	39	46	44	44
Order number	117-885-JB	117-886-JB	217-099-JB	117-887-JB	217-097-JB	217-098-JB



Type profi stackable container

For transport and warehouse goods

- For equipment and recyclable materials
- Extremely sturdy transport and stackable steel container
- Sturdy, hollow feet
- Corner posts with crane eyes (stacking containers can be lifted using a crane beam, only in vertical direction)
- Foot plates for storage without damaging the floor
- Easy to transport and stack
- Available either in blue (RAL 5010), grey (RAL 7005) or Hot-dip galvanised



Stacking container Model Profi, with 4 crane eyes for easy, safe handling



Model Profi stacking containers, available in different sizes and designs

Model	SP 5080	SP 8010	SP 8012	SP 1012
Capacity [l]	160	400	480	600
External dimensions W x D x H [mm]	800 x 500 x 500	1000 x 800 x 600	1200 x 800 x 600	1200 x 1000 x 600
Overall load capacity [kg]	2000	2000	2000	2000
Stacked load [kg]	10000	10000	10000	10000
Access width (long side) [mm]	660	860	1060	1060
Access width (short side) [mm]	360	660	660	860
Weight [kg]	27	44	49	57
Surface: painted				
Order number Grey	129-279-JB	129-285-JB	129-291-JB	129-297-JB
Order number Blue	129-280-JB	129-286-JB	129-292-JB	129-298-JB
Surface: Hot dip galvanised				
Order number	129-281-JB	129-287-JB	129-293-JB	129-299-JB

Reusable stacking container DENIOS classic-line D

For efficient storage, transport and picking

- In food safe polypropylene (PP)
- Can be stacked to save space
- Versions with stacking brackets and folding lid can be stacked one on top of each other
- Useful handles on 4 sides
- Temperature resistant from -10 °C to +60 °C

For containers without a lid and with stacking corners, the right lid can be found in the Online Shop.

classic-line
by DENIOS ■■



Available in 4 colours



External dimensions W x D x H [mm]	600 x 400 x 173	600 x 400 x 273	600 x 400 x 323	600 x 400 x 173	600 x 400 x 273	600 x 400 x 323	600 x 400 x 199	600 x 400 x 299	600 x 400 x 349
Features	Without lid	Without lid	Without lid	Stacking frame	Stacking frame	Stacking frame	Folding lids	Folding lids	Folding lids
Overall load capacity [kg]	25	30	35	25	30	35	25	30	35
Stacked load [kg]	200	200	200	200	200	200	200	200	200
Pack contents	3 Item(s)	3 Item(s)	2 Item(s)	3 Item(s)	3 Item(s)	2 Item(s)	3 Item(s)	3 Item(s)	2 Item(s)
Order number Blue	265-231-JB	265-235-JB	265-239-JB	265-251-JB	265-255-JB	265-259-JB	265-263-JB	265-267-JB	265-271-JB
Order number Red	265-232-JB	265-236-JB	265-240-JB	265-252-JB	265-256-JB	265-260-JB	265-264-JB	265-268-JB	265-272-JB
Order number Yellow	265-233-JB	265-237-JB	265-241-JB	265-253-JB	265-257-JB	265-261-JB	265-265-JB	265-269-JB	265-273-JB
Order number Green	265-234-JB	265-238-JB	265-242-JB	265-254-JB	265-258-JB	265-262-JB	265-266-JB	265-270-JB	265-274-JB



Euro stacking container DENIOS classic-line B



6

High quality, stable Euro container for transport and storage

- In food safe polypropylene (PP)
- Sturdy stable shape with rib-reinforced sides and edge all around
- Ergonomic handle
- Temperature resistant from -10 °C to +60 °C
- Versions available with moulded handles or handle openings in various colours
- Lockable with hinged lid or normal lid (accessory)

classic-line
by DENIOS ■■

ORDER AT THE SAME TIME



Slide fasteners for lid, set of 4

Colour	Blue	Red
Order number	265-222-JB	265-223-JB



Hinge fasteners for hinged lid, set of 4

Colour	Grey / blue	Grey / red
Order number	265-224-JB	265-225-JB



Handle variants
Closed moulded handles in grey or red, handle openings in grey or blue

External dimensions W x D x H [mm]	400 x 300 x 120	400 x 300 x 170	400 x 300 x 220	400 x 300 x 320	600 x 400 x 120	600 x 400 x 170	600 x 400 x 220	600 x 400 x 320
Overall load capacity [kg]	25	25	25	25	40	40	40	40
Stacked load [kg]	300	300	300	300	400	400	400	400
Pack contents	16 Item(s)	10 Item(s)	8 Item(s)	4 Item(s)	8 Item(s)	5 Item(s)	4 Item(s)	3 Item(s)
Features: Moulded handles								
Order number Colour: Grey	265-186-JB	265-187-JB	265-188-JB	265-189-JB	265-190-JB	265-191-JB	265-192-JB	265-193-JB
Order number Colour: Grey / red	265-202-JB	265-203-JB	265-204-JB	265-205-JB	265-206-JB	265-207-JB	265-208-JB	265-209-JB
Features: grip openings								
Order number Colour: Grey	265-194-JB	265-195-JB	265-196-JB	265-197-JB	265-198-JB	265-199-JB	265-200-JB	265-201-JB
Order number Colour: Grey / blue	265-210-JB	265-211-JB	265-212-JB	265-213-JB	265-214-JB	265-215-JB	265-216-JB	265-217-JB
Accessories								
Order number Lid (without locks)	265-226-JB	265-226-JB	265-226-JB	265-226-JB	265-227-JB	265-227-JB	265-227-JB	265-227-JB
Order number Hinged lid (without locks)	265-228-JB	265-228-JB	265-228-JB	265-228-JB	265-229-JB	265-229-JB	265-229-JB	265-229-JB

PRODUCTION AND OPERATION EQUIPMENT

Aluminium transport boxes with / without stacking corners

- For storing and transporting valuable goods
- Extra stable and robust
- In 1 mm thick aluminium sheet
- Reinforcing fins ensure good stability
- Rubber seal in the profile edge ensures protection from dust and spray
- Corrosion, weather and temperature resistant
- Low net weight
- Sturdy hinged fasteners
- Sturdy folding lid with straps to support the hinges
- Self-folding safety transport handle with plastic coating
- Cylinder lock available as an option
- Areas of application: collecting, storing and protecting valuable goods and equipment, transport of assembly equipment, tooling, small parts etc.



Aluminium transport boxes with stacking corners

Aluminium transport boxes without stacking corners



Version	W/out corners				
Capacity [l]	30	48	73	92	140
External dimensions W x D x H [mm]	430 x 335 x 273	580 x 385 x 285	580 x 385 x 398	780 x 385 x 367	900 x 495 x 367
Internal dimensions W x D x H [mm]	400 x 300 x 248	550 x 350 x 248	550 x 350 x 381	750 x 350 x 350	870 x 460 x 350
Overall load capacity [kg]	40	60	70	90	90
Weight [kg]	3.1	4.2	4.9	6.0	7.7
Order number	136-684-JB	136-686-JB	254-866-JB	136-688-JB	136-689-JB

ORDER AT THE SAME TIME

- Cylinder lock with 2 keys



Order no. 136-696-JB

Version	With corners									
Capacity [l]	30	48	73	92	140	157	153	243	425	
External dimensions W x D x H [mm]	430 x 335 x 277	580 x 385 x 277	580 x 385 x 410	780 x 385 x 379	900 x 495 x 379	782 x 585 x 410	1182 x 385 x 410	782 x 585 x 619	1192 x 790 x 514	
Internal dimensions W x D x H [mm]	400 x 300 x 248	550 x 350 x 248	550 x 350 x 381	750 x 350 x 350	870 x 460 x 350	750 x 550 x 381	1150 x 350 x 381	750 x 550 x 590	1160 x 755 x 485	
Overall load capacity [kg]	40	60	70	90	90	90	90	100	110	
Weight [kg]	3.1	4.0	4.8	5.7	7.2	7.4	8.7	8.9	14.5	
Order number	254-867-JB	136-690-JB	136-691-JB	136-692-JB	136-693-JB	254-893-JB	144-768-JB	136-695-JB	144-769-JB	



Aluminium transport boxes without stacking corners

- For safe storage and easy transport
- With 2 cylinder locks as standard
- Aluminium thickness: 0.8 mm, high stability with special aluminium profiles and ribbing
- Rubber seal in the profile edge ensures protection from dust and spray
- Corrosion, weather and temperature resistant
- Low weight ensures easy transport
- Self-folding safety transport handle with plastic coating
- Sturdy hinged fasteners
- Lockable with cylinder locks, 2 keys included
- Sturdy folding lid with straps to support the hinges



	1	2	3	4	5	6
Version	W/out corners					
Capacity [l]	30	48	68	93	142	186
External dimensions W x D x H [mm]	430 x 335 x 270	575 x 385 x 270	575 x 385 x 375	775 x 385 x 375	895 x 495 x 375	785 x 565 x 482
Internal dimensions W x D x H [mm]	405 x 300 x 250	550 x 350 x 250	550 x 350 x 355	750 x 350 x 355	870 x 460 x 355	760 x 530 x 462
Overall load capacity [kg]	40	60	70	90	90	70
Weight [kg]	2.6	3.4	3.8	4.6	5.9	6.3
Order number	254-860-JB	254-861-JB	254-862-JB	254-863-JB	254-864-JB	254-865-JB

Shelf bins DENIOS classic-line A

For optimum overview and quick access to small parts

- In polypropylene (PP)
- Secure stacking, keeps its shape and sturdy
- Textured base for improved removal of small parts
- Moulded handles on the front side for secure handling
- Temperature resistant from -10 °C to +60 °C

classic-line
by DENIOS



ESD shelf bins are available in the DENIOS Online Shop.

ORDER AT THE SAME TIME



Labels with protective foil for individual labelling

Order no. 265-166-JB



Transparent dividers for better overview

Order no. 265-163-JB



Pull out stops allow angled shelf positioning

Order no. 265-165-JB



Design	A1-S	A1-B	A2-S	A2-B	A3-S	A3-B
External dimensions W x D x H [mm]	91 x 300 x 81	185 x 300 x 81	91 x 400 x 81	185 x 400 x 81	91 x 500 x 81	185 x 500 x 81
Overall load capacity [kg]	2	5	2	5	2	5
Stacked load [kg]	6	15	6	15	6	15
Pack contents	16 Item(s)	8 Item(s)	16 Item(s)	8 Item(s)	16 Item(s)	8 Item(s)
Order number Blue	265-151-JB	265-153-JB	265-155-JB	265-157-JB	—	265-161-JB
Order number Red	265-152-JB	265-154-JB	265-156-JB	265-158-JB	265-160-JB	265-162-JB
Accessories						
Order number Labels (1 pack = 20 pieces)	265-166-JB	265-167-JB	265-166-JB	265-167-JB	265-166-JB	265-167-JB
Order number Dividers (1 pack = 4 pieces)	265-163-JB	265-164-JB	265-163-JB	265-164-JB	265-163-JB	265-164-JB
Order number Pull out stops (1 pack = 10 pieces)	265-165-JB	265-165-JB	265-165-JB	265-165-JB	265-165-JB	265-165-JB



Open-fronted storage bins DENIOS pro-line A

TÜV tested quality, for clear, safe storage of small parts

- In polypropylene (PP)
- Safe to stack, with sturdy stable shape with edge all around
- Comfortable moulded handle on the front
- Smooth inner surfaces for quick, easy cleaning
- Temperature resistant from -10 °C to +60 °C
- Strip at the rear for attaching to wall mounts (only for versions A1 to A3)
- Moulded handle on the rear for simple handling when full (only for versions A4 and A5)

ESD open-fronted storage bins are available in the DENIOS Online Shop.

pro-line
by DENIOS

ORDER AT THE SAME TIME



Wall mounting in metal, for open-fronted storage bins variants A1 to A3

Order no. 265-145-JB



The sturdy open-fronted storage bins allow small items to be stored with a good overview. In order to use the space available in production or the warehouse, bins of the same size can be stacked one on top of another.



Design	A1	A2	A2-B	A2-L	A3	A4	A5
External dimensions W x D x H [mm]	100 x 100 x 60	100 x 160 x 75	135 x 160 x 82	100 x 215 x 75	150 x 235 x 125	205 x 355 x 150	310 x 500 x 200
Overall load capacity [kg]	2	3	3	3	10	25	35
Stacked load [kg]	6	9	9	9	40	100	140
Pack contents	30 Item(s)	24 Item(s)	20 Item(s)	20 Item(s)	24 Item(s)	12 Item(s)	6 Item(s)
Order number Blue	265-106-JB	265-111-JB	265-136-JB	265-131-JB	265-116-JB	265-121-JB	265-126-JB
Order number Red	265-107-JB	265-112-JB	265-137-JB	265-132-JB	265-117-JB	265-122-JB	265-127-JB
Order number Yellow	265-108-JB	265-113-JB	265-138-JB	265-133-JB	265-118-JB	265-123-JB	265-128-JB
Order number Green	265-109-JB	265-114-JB	265-139-JB	265-134-JB	265-119-JB	265-124-JB	265-129-JB
Order number Grey	265-110-JB	265-115-JB	265-140-JB	265-135-JB	265-120-JB	265-125-JB	265-130-JB
Accessories							
Order number Labels (1 pack = 20 pieces)	265-141-JB	265-141-JB	265-141-JB	265-141-JB	265-142-JB	265-143-JB	265-144-JB

Big Bags for storage, operations and disposal

- Flexible storage, transport and disposal containers
- With 4 lifting loops for transport by forklift, crane etc
- Minimal space requirement when not filled



1 For bulk goods - Big Bag S 1000

- For bulk goods such as plastic granulate, recycling material, fertiliser, corn and much more
- Made out of uncoated polypropylene fabric
- With in and outlet



3 Versatile - Big Bag L/e 1000

- For Universal use from interim storage to disposal (e.G. as a leaf sack etc.)
- Made out of uncoated polypropylene fabric
- With apron for upper cover
- Closed floor



2 Dust proof - Big Bag S 1250 (no picture)

- For all pulverised, dusty bulk goods
- Made out of uncoated polypropylene fabric
- Seam welding
- With in and outlet

4 Big Bags for storage, operations and disposal

- For stones, sand, gravel, green waste, bark, mulch etc
- Made out of uncoated polypropylene fabric
- Top open
- Closed floor

5 Big Bag Asbest (without image)

- Specifically for disposing ASBESTOS
- Made out of uncoated polypropylene fabric
- "Asbestos" sign
- With apron for upper cover
- Closed floor

	1	2	3	4	5
Model	S 1.000	S 1.250	L / E 1.000	L / E 1.500	Asbestos
External dimensions W x D x H [mm]	910 x 910 x 1750	910 x 910 x 1250	910 x 910 x 1100	900 x 900 x 900	900 x 900 x 1100
Overall load capacity [kg]	1000	1250	1000	1500	1000
Big Bag safety factor	5:1	5:1	5:1	5:1	5:1
Big Bag opening	Filling pipe (Ø 500 mm)	Filling pipe (Ø 400 mm)	Apron	Open	Apron
Floor Big Bag	Dispensing nozzle (Ø 400 mm)	Dispensing nozzle (Ø 400 mm)	Closed	Closed	Closed
Pack contents	10 Item(s)	10 Item(s)	10 Item(s)	10 Item(s)	10 Item(s)
Order number	174-000-JB	173-999-JB	173-998-JB	173-996-JB	173-997-JB



Lifting crosses for Big Bags

- Safety and practical handling of Big Bags
- Very robust design made out of painted steel profile pipe
- Easy and safe operation with loop attachment in 4 stainless steel hooks (to prevent unintended unhooking)
- Ideal for keeping the Big Bags firm when emptying



Big Bag lifting cross with angled mounting points for additional height

Order no. 181-320-JB



Big Bag lifting cross with standard equipment

Order no. 180-733-JB

Version	Standard	Curved
External dimensions W x D [mm]	1055 x 1055	1055 x 1055
Overall load capacity [kg]	1500	1500
Order number	180-733-JB	181-320-JB

Your flexible Big Bag fitting

- To easily open and close Big Bags
- For stepless control of product flow
- Hygienic - no contact with filler
- Flexible and economical - smooth, manual operation
- Can be used immediately - without electrical connection or aids
- Almost wear-free
- With 4 belts and stainless steel hooks to quickly fix to Big Bags



The product flow can be steplessly regulated



Big Bag outlet frame for manual operation, with 4 hanger straps and hooks

Opening diameter [mm]	250	300
External dimensions W x D x H [mm]	430 x 430 x 60	490 x 490 x 60
Weight [kg]	3	4
Order number	180-735-JB	180-736-JB

Fork-lift frame for Big Bag

- Stack Big Bags safely
- In galvanised steel
- Very robust and can be stacked on 3 levels
- Comprised of base section, upper section and 4 connection pipes, each 2 M (length adjustable)
- Fork pockets for transport with fork lift



The Big Bag stacking frame can be taken apart without tools for space saving storage



1 Upper frame

2 Base frame

Version	Base frame	Upper frame
External dimensions W x D x H [mm]	1250 x 1250 x 2350	1250 x 1250 x 2350
Overall load capacity [kg]	1000	1000
Weight [kg]	80	80
Order number	180-737-JB	181-319-JB

Grit bin model SB

Grit bins from denios

- Robust and weather-resistant grit bin in polyethylene (PE)
- Corrosion-proof and impact-resistant
- Lid can be removed easily without the need for tools
- Lockable container (lock not supplied)
- Body available in light grey with coloured lid in yellow, orange or green
- Available with or without dispensing hatch



Grit bins in 7 sizes, optionally with or without dispensing hatch, available in three lid colours.



Grit bin Model SB 200-0, 200 litre volume, with dispensing hatch and controlled flow rate of grit

Order no. 145-274-JB



Grit bin SB 100 with 100 litre capacity

Order no. 136-420-JB

Model	SB 60	SB 100	SB 200	SB 400	SB 550	SB 700	SB 1000
Features	Without dispensing hatch						
Capacity [l]	60	100	200	400	550	700	1000
External dimensions W x D x H [mm]	620 x 510 x 450	975 x 705 x 460	975 x 705 x 665	1210 x 785 x 780	1400 x 1070 x 748	1400 x 1070 x 930	1800 x 1350 x 960
Order number Orange	201-265-JB	145-284-JB	145-286-JB	145-288-JB	145-290-JB	145-292-JB	156-600-JB
Order number Green	-	145-285-JB	145-287-JB	145-289-JB	145-291-JB	145-293-JB	156-599-JB
Order number Yellow	-	136-420-JB	129-346-JB	122-904-JB	136-421-JB	136-423-JB	156-598-JB

Model	SB 100-o	SB 200-o	SB 400-o	SB 550-o	SB 700-o	SB 1000-o
Features	With dispensing hatch					
Capacity [l]	100	200	400	550	700	1000
External dimensions W x D x H [mm]	975 x 705 x 460	975 x 705 x 665	1210 x 785 x 780	1400 x 1070 x 748	1400 x 1070 x 930	1800 x 1350 x 960
Order number Orange	145-272-JB	145-274-JB	145-276-JB	145-280-JB	145-282-JB	156-604-JB
Order number Green	145-273-JB	145-275-JB	145-279-JB	145-281-JB	145-283-JB	156-603-JB
Order number Yellow	136-424-JB	129-347-JB	122-905-JB	136-425-JB	136-426-JB	156-602-JB



Innovative
product designs



International
Forum
Design

Grit bin model SB 400-0, 400 litres volume, with
dispensing hatch and controlled flow rate of grit

Order no. 145-276-JB



Grit bin type SB 400, volume 400 litres, without
dispensing hatch, base frame with 4 swivel castors
can be supplied as an accessory..

Order no. 145-289-JB

Functional information and accessories



Models SB 100 - 1000 can be stacked inside each
other. This means the grit bins can be stored for
example over the summer without taking up much
room



The sturdy positive hinges are long lasting and
maintenance-free

**Models SB 100 to 550 are available
either with castors or with feet
(see accessories).**



Swivel castors



Swivel castors

ORDER AT THE SAME TIME

Grit bins SB 100 to SB 550 are available with either swivel
castors or feet (for SB 400 and SB 550 with stabilising
base frame). This enables the bin to be transported by pallet
truck or forklift truck, even when full.

For model	SB 100/200	SB 400	SB 550
Order number 4 swivel castors	129-348-JB	130-033-JB	136-494-JB
Order number 4 legs	129-349-JB	130-034-JB	136-495-JB



Base frame with 4 swivel castors,
for model SB 400 and SB 550

Base frame with 4 base feet,
for model SB 400 and SB 550



Grit bin model GB 300 with 300 litre capacity, ideal for storing salt, grit or sand

Grit bin model GB

- Robust grit bin in polyethylene (PE)
- Impact resistant, durable and weather resistant
- Forklift pockets for simple access underneath and transport by a pallet truck or forklift
- Space saving design with and without lid, stackable up to 5 high
- With inbuilt lock to protect against unauthorised access
- Overhanging lid prevents precipitation from penetrating and therefore protects the grit from clumping
- Sturdy handles at the sides for manually transporting the container when empty
- Lid with robust hinge, light and easy to fit/remove without the need for tooling
- Dark grey body with coloured lid (either yellow or orange)



Capacity [l]	150	150	300	300
External dimensions W x D x H [mm]	1015 x 675 x 660	1015 x 675 x 660	1150 x 810 x 845	1150 x 810 x 845
Lid colour	Yellow	Orange	Yellow	Orange
Order number	241-875-JB	241-876-JB	241-877-JB	241-878-JB

Shovels

- Ideal for using with grit, salt and other aggressive substances
- In polypropylene (PP)
- Corrosion free, long lasting
- UV stabilised and impact resistant
- Low net weight



Model	Scoop	Scoop	Shovel with d-handle	Shovel with d-handle
External dimensions W x D x H [mm]	138 x 187 x 310	167 x 230 x 355	247 x 315 x 966	257 x 350 x 1032
Order number Red	165-377-JB	165-378-JB	165-380-JB	165-383-JB

Snow shovel

- Ideal for using with grit, salt and other aggressive substances
- Base in polypropylene (PP) and handle in wood
- Corrosion free
- High stability with a low net weight ensure ergonomic work and long life
- UV stabilised and impact resistant
- UV stabilised
- Shovel dimensions W x D (mm) 500 x 355, with handle H (mm) 1300

Order no. 165-638-JB





Winter grit without salt WinterSafe, 50 l bag

Environmentally friendly granules of volcanic origin.

- Stumps sidewalks and traffic areas. Prevents slipping.
- Immediate and long-lasting effect.
- Without salt - marked with the Blue Angel environmental symbol. No danger to plants, animals or the environment. The sustainable alternative to de-icing salt.
- High yielding. Sufficient for an area of 1,200 - 1,800 m².
- WinterSafe grit can be distributed mechanically or manually. There are no temperature restrictions for use as with salts, as it works independently of temperature.



Order no. 269-723-JB



GritCaddy GRIT TROLLEY

- Make sure granules, sand, absorbents and other granular materials are always available where you need them fast, both indoors and outdoors
- Optimum centre of gravity to make handling easier
- Slightly sloping lid to ensure water runs off: can also be used as a carrying surface
- With smooth-running wheels and large, comfortable handle
- In environmentally-friendly, highly chemical resistant polyethylene (PE)
- Weatherproof
- Easy to clean
- Fully recyclable



Granules and compact hand shovels can be stowed away in the roomy storage area of the GritCaddy



The GritCaddy is your reliable tool for distributing granules of all types. It has an ergonomic handle, which can be gripped even with thick gloves, a slightly sloping lid to allow water to run off and easy to move 200 mm diameter wheels.

Model	Gritcaddy
Capacity [l]	60
External dimensions W x D x H [mm]	700 x 670 x 1145
Order number	216-690-JB

Please state the size you require with the order!

Grit bins

See page
560



Storage shelves

- Flexible, sturdy storage system with push-fit, easy assembly
- For the professional and individual storage of workshop materials, production accessories etc.
- Galvanised frame
- 4 galvanised shelves for storage
- Sturdy construction with reinforcing crossbars
- Shelving height can be adjusted in 25 mm increments
- Can be expanded at any time
- Delivered flat packed with instructions for easy self assembly



Each basic shelving unit consists of 2 galvanised frames, extension shelving units have one frame. The galvanised shelves are fitted in special reinforced cross members. This allows just a few individual components to create a stable yet flexible shelving system.



Bay dimensions W x D [mm]	1000 x 500	1000 x 500	1000 x 600	1000 x 600	1300 x 500	1300 x 500	1300 x 600	1300 x 600
Equipment - shelves	4 x shelf, galvanised	4 x shelf, galvanised	4 x shelf, galvanised	4 x shelf, galvanised	4 x shelf, galvanised	4 x shelf, galvanised	4 x shelf, galvanised	4 x shelf, galvanised
Load [kg]	150	150	150	150	250	250	250	250
Rack load [kg]	1300	1300	1300	1300	1300	1300	1300	1300
Height, external [mm]	1800	2300	1800	2300	1800	2300	1800	2300
Basic shelf								
External dimensions W x D x H [mm]	1060 x 537 x 1800	1060 x 537 x 2300	1060 x 637 x 1800	1060 x 637 x 2300	1360 x 537 x 1800	1360 x 537 x 2300	1360 x 637 x 1800	1360 x 637 x 2300
Order number	199-677-JB	199-679-JB	199-681-JB	199-683-JB	199-685-JB	199-687-JB	199-689-JB	199-691-JB
Extension shelf								
External dimensions W x D x H [mm]	1012 x 537 x 1800	1012 x 537 x 2300	1010 x 637 x 1800	1012 x 637 x 2300	1312 x 537 x 1800	1312 x 537 x 2300	1312 x 637 x 1800	1312 x 637 x 2300
Order number	199-678-JB	199-680-JB	199-682-JB	199-684-JB	199-686-JB	199-688-JB	199-690-JB	199-692-JB
Accessories								
	Additional surface	Additional surface	Additional surface	Additional surface	Additional surface	Additional surface	Additional surface	Additional surface
Order number	199-693-JB	199-693-JB	199-694-JB	199-694-JB	199-695-JB	199-695-JB	199-696-JB	199-696-JB



Pallet racking

- Pallet racks save space, reduce processing time, improve working practices and so increase productivity
- Sturdy shelving system for all loading aids for example Euro or mesh box pallets
- Ideal for efficient, orderly and adaptable pallet storage
- Shelving frame galvanised, cross members powder coated red-orange (RAL 2001)
- 2 pairs of cross members as storage levels
- Adjustable shelf height through hole distance of 50 mm
- Can be expanded at any time
- Delivered flat-pack, with instructions for assembly



Additional rack collision protection

See page
596

Collision protection
CORNER

Order no. 203-606-JB

ORDER AT THE SAME TIME



Euro mesh box exchange pallet meeting UIC standard 435-3, ideal for storage and transport

Order no. 129-203-JB

ORDER AT THE SAME TIME



Galvanised shelves allow direct storage of individual packets for example, see table; not suitable for pallet storage or use with a forklift.



Galvanised grids to store different sized storage media next to each other or to create commissioning areas in shelves, see table.



Shelf guards prevent the load carrier / pallets from being pushed too far, see table.



Angular supports are required for the storage of mesh boxes in the rack. The lateral guide of the angular support ensures safe storage of the mesh box.

Order no. 199-673-JB



Frame extension, 500 mm this ensures that the required drop protection of a minimum of 500 mm from the upper edge of the upper cross member is maintained

Order no. 199-670-JB



Each shelf level is supplied with 2 pairs of transverse members, additional transverse members can be used (see accessories table).

Bay dimensions W x D [mm]	1825 x 1100	1825 x 1100	2700 x 1100	2700 x 1100	3300 x 1100	3300 x 1100
Load [kg]	2200	2200	3540	3540	3780	3780
Rack load [kg]	4400	4400	7080	7080	7560	7560
Height, external [mm]	2700	3800	2700	3800	2700	3800
Basic shelf						
External dimensions W x D x H [mm]	2025 x 1100 x 2700	2025 x 1100 x 3800	2900 x 1100 x 2700	2900 x 1100 x 3800	3500 x 1100 x 2700	3500 x 1100 x 3800
Order number	266-319-JB	266-321-JB	199-699-JB	199-705-JB	199-701-JB	199-707-JB
Extension shelf						
External dimensions W x D x H [mm]	1925 x 1100 x 2700	1925 x 1100 x 3800	2800 x 1100 x 2700	2800 x 1100 x 3800	3400 x 1100 x 2700	3400 x 1100 x 3800
Order number	266-320-JB	266-322-JB	199-700-JB	199-706-JB	199-702-JB	199-708-JB
Accessories						
Order number Shelf guard, galvanised	266-325-JB	266-325-JB	199-540-JB	199-540-JB	199-545-JB	199-545-JB
Order number Additional transverse pairs	266-323-JB	266-323-JB	199-710-JB	199-710-JB	199-711-JB	199-711-JB
Order number Shelves, galvanised	199-674-JB	199-674-JB	199-675-JB	199-675-JB	199-676-JB	199-676-JB
Order number Grids / shelves, galvanised	200-237-JB	200-237-JB	120-232-JB	120-232-JB	145-616-JB	145-616-JB

Equipment and tooling cabinets with drawers and galvanised shelves

- Designed for everyday industrial use
- Drawers with telescopic slides - can be pulled out to 80%
- High quality, impact and scratch resistant powder coating
- Wing doors with handle, 3 point lock and 2 keys
- Height adjustable in increments of 33 mm



	1	2	3	4	5
Features	1 drawer, 2 shelves	3 drawers, 1 shelf	2 drawers, 2 shelves, full-width	2 drawers, centre partition, 4 shelves	6 drawers, centre partition, 2 shelves
Body dimensions W x D x H [mm]	500 x 500 x 1000	500 x 500 x 1000	1000 x 500 x 1000	1000 x 500 x 1000	1000 x 500 x 1000
Shelf load capacity [kg]	50	50	50	50	50
Drawer load capacity [kg]	25	25	25	25	25
Order number Doors light grey	251-800-JB	251-802-JB	251-808-JB	251-804-JB	251-806-JB
Order number Doors gentian blue	251-801-JB	251-803-JB	251-809-JB	251-805-JB	251-807-JB



The numerous drawers allow small objects to be stored with order and clarity

	1	2	3
Features	4 shelves, full-width	8 shelves, centre partition	4 shelves, centre partition, 16 drawers
Body dimensions W x D x H [mm]	1000 x 500 x 1800	1000 x 500 x 1800	1000 x 500 x 1800
Shelf load capacity [kg]	50	50	50
Drawer load capacity [kg]	25	25	25
Order number Doors light grey	251-810-JB	251-812-JB	251-814-JB
Order number Doors gentian blue	251-811-JB	251-813-JB	251-815-JB



Equipment and tooling cabinets with slide-out spill trays and drawers

DENIOS ONLINE SHOP

There's even more choice in the shop!

>> www.denios.co.uk <<



1 **2** **3** **4** **5**

Features	4 spill trays, can be pulled out	1 drawer 100 mm, 3 spill trays, can be pulled out	3 drawers 100 mm, 3 spill trays full-width, can be pulled out	6 drawers 100 mm, 2 drawers 200 mm, centre partition, 6 spill trays, can be pulled out	14 drawers 100 mm, centre partition, 4 spill trays, can be pulled out
Body dimensions W x D x H [mm]	500 x 500 x 1800	500 x 500 x 1800	1000 x 500 x 1800	1000 x 500 x 1800	1000 x 500 x 1800
Load capacity of shelf [kg]	35	35	35	35	35
Order number Doors light grey	251-844-JB	251-848-JB	251-858-JB	251-868-JB	251-872-JB
Order number Doors gentian blue	251-845-JB	251-849-JB	251-859-JB	251-869-JB	251-873-JB

XXL- cabinets - ideal for bulky objects

- Equipment cabinets with high storage volume - 80 mm cabinet depth
- Long lasting steel construction, body light grey, with high-quality stove-enamelling
- Shelves are height adjustable in increments of 15 mm
- Viewing window in acrylic glass (3 mm) - gives a quick overview of the cabinet contents
- Load capacity of shelf: 70 kg, cabinet load capacity 450 kg
- 3-bolt recessed handle lock Ergo-Lock 4.0, with 2 keys and patented mechanism: Simply press to close. Easy to use when wearing gloves

Roomy storage - the sturdy, proven XXL cabinets in the Cabo range offer more storage than conventional equipment cabinets.



Model	930-4	930-4	1200-4	1200-4
Design	4 inlay shelves	4 inlay shelves	4 inlay shelves	4 inlay shelves
Body dimensions W x D x H [mm]	930 x 800 x 1950	930 x 800 x 1950	1200 x 800 x 1950	1200 x 800 x 1950
Door version	hinged door	Wing door with viewing window	hinged door	Wing door with viewing window
Order number Doors light grey	255-974-JB	255-978-JB	256-010-JB	256-014-JB
Order number Doors gentian blue	255-975-JB	255-979-JB	256-011-JB	256-015-JB



Inox stainless steel multipurpose cabinet - various uses

- Long-term protection against corrosion
- Easy to clean and hygienic
- Suitable for damp and wet rooms
- Flexible use, in medical or chemical industries for example
- Stainless steel V2A-4301, 1 mm thick, brushed on one side
- Chemically resistant, anti-magnetic
- Wing doors with cylinder lock
- Shelves adjustable in steps of approx. 20 mm, load capacity 70 kg
- 3 cabinet depths
- Windows in acrylic glass

DENIOS ONLINE SHOP



There's even more choice in the shop!

>> www.denios.co.uk <<



Model	1000-4	1000-4	1000-4	1000-2	1000-2	1000-2	1000-4	1000-4	1000-4
Body dimensions W x D x H [mm]	1000 x 400 x 1950	1000 x 500 x 1950	1000 x 600 x 1950	1000 x 400 x 1050	1000 x 500 x 1050	1000 x 600 x 1050	1000 x 400 x 1950	1000 x 500 x 1950	1000 x 600 x 1950
Design	4 shelves	4 shelves	4 shelves	2 shelves	2 shelves	2 shelves	4 shelves	4 shelves	4 shelves
Door version	hinged door	hinged door	hinged door	hinged door	hinged door	hinged door	hinged door with glass insert	hinged door with glass insert	hinged door with glass insert
Order number	251-569-JB	251-570-JB	251-571-JB	251-581-JB	251-582-JB	251-583-JB	251-584-JB	251-585-JB	251-586-JB



Sliding door cabinets Cabo

Practical sliding door cabinets need just a small footprint and have large, secure doors, suitable for use even in a tough environment. Body in light grey (RAL 7035), doors in either gentian blue (RAL 5010) or light grey (RAL 7035)

- Space-saving sliding doors on castors, easy to manoeuvre and secure
- Long lasting steel construction, with high-quality stove enamelling
- Height adjustable shelves (in increments of 15 mm), galvanised, load capacity 70 kg
- Push cylinder lock with 2 keys, interchangeable core type cylinder
- 1600 mm wide models with centre panel, 4 shelves each on the left and right
- Ergonomic, metal handle

Model	1200-4	1200-4	1200-4	1600-8	1600-8	1600-8
Body dimensions W x D x H [mm]	1200 x 400 x 1950	1200 x 500 x 1950	1200 x 600 x 1950	1600 x 400 x 1950	1600 x 500 x 1950	1600 x 600 x 1950
Design	4 inlay shelves	4 inlay shelves	4 inlay shelves	8 shelves	8 shelves	8 shelves
Order number Doors gentian blue	255-932-JB	255-936-JB	255-942-JB	255-944-JB	255-946-JB	255-948-JB
Order number Doors light grey	255-931-JB	255-935-JB	255-941-JB	255-943-JB	255-945-JB	255-947-JB

Vertical cabinets - maximum ease of use thanks to direct access from both sides

Vertical cabinets allow space-saving storage of tools, work materials and more in a confined space.

- Maximum storage space on a minimum footprint - pure efficiency
- High load capacities, vertical pull-outs can be loaded up to 200 kg
- Sturdy steel construction, frame load capacity up to 1000 kg, powder-coated light grey, RAL 7035
- Perfect running smoothness, even at high loads
- Convincing safety with standard single drawer locking for tip prevention
- Highest operating comfort, with direct access to tools and small parts on both sides
- For space-saving storage of tools, working materials in confined spaces. Maximum storage space, minimum footprint



Pull-out perforated walls are used for flexible storage of the stored goods



With slide out and adjustable shelves, for clear and systematic storage

Design	4 pull-outs with perforated walls, (H x D) 1700 x 560 mm	3 pull-outs with perforated walls, (H x D) 1700 x 560 mm	4 pull-outs with perforated walls, (H x D) 1700 x 612 mm	3 pull-outs with 4 height-adjustable shelves	3 pull-outs with perforated walls, (H x D) 1700 x 612 mm, can be used on both sides	4 pull-outs with 4 height-adjustable shelves
Body dimensions W x D x H [mm]	1000 x 600 x 1950	1000 x 600 x 1950	1000 x 695 x 1950	1000 x 695 x 1950	1000 x 695 x 1950	1000 x 695 x 1950
Weight [kg]	103	98	185	167	157	188
powder coated	273-119-JB	273-120-JB	273-121-JB	273-122-JB	273-123-JB	273-124-JB

Heavy duty cabinets - highest stability for high loads

Heavy duty cabinets are suitable for storing heavy materials. Maximum stability is guaranteed by a frame load capacity of up to 1500 kg.

- Available with swing-in or wing doors
- High loads, 160 kg per shelf/200 kg per drawer
- Housing with impact and abrasion resistant surface
- Convincing safety with individual drawer lock to prevent tipping over on heavy-duty cabinets with hinged doors
- Can be adapted to new stored goods at any time thanks to the flexible installation and conversion of drawers, pull-out shelves and adjustable shelves in 25 mm increments
- Welded sheet steel construction with integrated support column system
- Key lock = standard locking with exchangeable cylinder incl. 2 keys with key number. Simple adaptation to existing locking systems. Use as main locking system (max. 100 cylinders), different or same locking



Hinged doors - disappear into the enclosure when opened for the clearest possible access to the contents of the cabinet

Design	4 shelves	2 shelves, 2 slide-out shelves, 3 drawers (2 x H 75, 1 x H 150 mm)	4 shelves, galvanised, 35 mm	3 shelves, galvanised, 35 mm, 2 drawers, each 1 x H 100/150 mm
Body dimensions W x D x H [mm]	1146 x 690 x 1950	1146 x 690 x 1950	1100 x 641 x 1950	1100 x 641 x 1950
Door version	Hinged doors	Hinged doors	hinged door	hinged door
Weight [kg]	155	212	212	141
powder coated	273-077-JB	273-078-JB	273-079-JB	273-080-JB

Tooling and equipment cabinets Cabo with wing doors, for workshops and offices

Long-lasting steel design for storing tools and equipment in a tough environment.

- Highly flexible, incl. 4 height adjustable (in steps of 15 mm), galvanised shelves
- High degree of operational safety and resistance to wear
- 3-bolt recessed handle lock Ergo-Lock, with 2 keys and patented mechanism: Simply press to close!
Easy to use when wearing gloves.
- High quality stove enamelling, body and doors in light grey (RAL 7035) or doors in gentian blue (RAL 5010)
- Attractive design, incl. base
- Available as a standard or heavy duty cabinet

BESTSELLERS



Standard cabinet:

- Doors open to approx. 110°
- Door stiffener ensures high door stability
- Load capacity per galvanised shelf 70 kg
- Cabinet load 450 kg



Heavy duty cabinet, cabinet load capacity 450 kg

- Doors hung on external hinges, approx. 180° opening angle
- Doors reinforced for high door stability and hidden locking bar
- Cabinet load 700 kg

Model	Standard	Standard	Standard	Standard
Body dimensions W x D x H [mm]	930 x 400 x 1950	930 x 500 x 1950	930 x 600 x 1950	1200 x 500 x 1950
Shelf load capacity [kg]	70	70	70	70
Order number Doors grey	243-720-JB	243-721-JB	255-971-JB	243-722-JB
Order number Doors blue	243-746-JB	243-747-JB	255-970-JB	243-748-JB

Model	Heavy duty	Heavy duty	Heavy duty	Heavy duty
Body dimensions W x D x H [mm]	930 x 400 x 1950	930 x 500 x 1950	930 x 600 x 1950	1200 x 500 x 1950
Shelf load capacity [kg]	110	110	110	110
Order number Doors grey	255-958-JB	243-723-JB	243-724-JB	255-986-JB
Order number Doors blue	255-957-JB	243-749-JB	243-750-JB	255-987-JB

Locker and cleaning cabinet Cabo

For the optimal accommodation of clothing and material

- Sturdy sheet steel construction with high quality stove-enamel coating
- Body and doors in light grey (RAL 7035) or doors in gentian blue (RAL 5010)
- Reinforced doors, door hinge right, with soft stop damper and closed side profiles for high stability
- Doors with ventilation gills and stamped label frames
- Additional rear vents at the top and bottom
- Security twist lock for padlock, with door protection
- Bottom part galvanized for increased corrosion protection
- Compartment floor smooth sweepable
- Optionally with sturdy plastic feet or on corrosion-protected base, each 100 mm high



Standard equipment for locker per section:
1 welded shelf, 1 oval-profile clothes rail
with 3 secure sliding double hooks



Alternatively available
with plastic feet

External dimensions W x D x H [mm]	600 x 500 x 1950	900 x 500 x 1950	1200 x 500 x 1950	600 x 500 x 1950	900 x 500 x 1950	1200 x 500 x 1950
Features	2 compartments	3 compartments	4 compartments	2 compartments	3 compartments	4 compartments
Door colour	Gentian violet	Gentian violet	Gentian violet	Light grey	Light grey	Light grey
Order number	308-266-JB	308-267-JB	308-268-JB	308-272-JB	308-273-JB	308-274-JB

External dimensions W x D x H [mm]	600 x 500 x 1950	900 x 500 x 1950	1200 x 500 x 1950	600 x 500 x 1950	900 x 500 x 1950	1200 x 500 x 1950
Features	2 compartments	3 compartments	4 compartments	2 compartments	3 compartments	4 compartments
Door colour	Gentian violet	Gentian violet	Gentian violet	Light grey	Light grey	Light grey
Order number	308-263-JB	308-264-JB	308-265-JB	308-269-JB	308-270-JB	308-271-JB



Standard equipment for lockers: 4 shelves on
the left, shelf with clothes rail and 3 sliding
double hooks on the right



Standard equipment cleaning agent
cabinets: on the left of the shortened
middle wall 4 shelves, on the right bar
with 3 double sliding hooks

Model	Linen cabinet	Linen cabinet	Linen cabinet	Linen cabinet	Cleaning cabinet	Cleaning cabinet	Cleaning cabinet	Cleaning cabinet
External dimensions W x D x H [mm]	600 x 500 x 1950	600 x 500 x 1950	600 x 500 x 1950	600 x 500 x 1950	600 x 500 x 1950	600 x 500 x 1950	600 x 500 x 1950	600 x 500 x 1950
Door colour	Gentian violet	Gentian violet	Light grey	Light grey	Gentian violet	Gentian violet	Light grey	Light grey
Design	On feet	On base	On feet	On base	On feet	On base	On feet	On base
Order number	308-277-JB	308-278-JB	308-275-JB	308-276-JB	308-281-JB	308-282-JB	308-279-JB	308-280-JB