



GENERAL CATALOG

2024.4.B(E)

CEDAR[®]

ALLIANCE SUPPLIES SDN.BHD.

www.alliance-supplies.com | www.alliancesuppliesonline.com.my | info@alliance-supplies.com | T:+606 3338889/8887/8898



We keep providing high performance and high quality products trusted by our customer.

Calibration certificates, Inspection certificates, Traceability system chart

All torque measuring instruments come with a calibration certificate, inspection certificate, and traceability system chart free of charge.

Calibration service

Periodic calibration inspections are necessary to maintain the accuracy of torque measuring instruments. Since we are a specialized manufacturer that designs and manufactures torque measuring instruments as well as provides after-sales service, high calibration accuracy is guaranteed.

After service

If the torque measuring instrument malfunctioned, we will repair it. For discontinued products, we will repair them if the date of discontinuation is within 5 years. However, there are cases in which repair may not be possible due to the production status of parts at our suppliers. Please understand this in advance. We also offer periodic inspections of our measuring instruments. Please contact the dealer where you purchased your instrument.

Torque testers are available for a variety of tightening tools.

For managing electric screwdriver



For managing click type torque driver



For managing click type torque wrench













For managing impact tool and torque wrench



Index (For managing the tightening tools)



Electric screwdriver	Torque driver	Torque wrench	Impact tool	0.01	0.1	1	10	100	1000	
<input type="checkbox"/>	<input type="checkbox"/>	<input type="checkbox"/>		0.002~25 N·m						
<input type="checkbox"/>	<input type="checkbox"/>			0.002~8 N·m						
<input type="checkbox"/>				0.01~10 N·m						
<input type="checkbox"/>	<input type="checkbox"/>			0.002~8 N·m						
<input type="checkbox"/>			<input type="checkbox"/>	0.3~25 N·m						
		<input type="checkbox"/>		7~200 N·m						
	<input type="checkbox"/>	<input type="checkbox"/>		0.002~1500 N·m						
<input type="checkbox"/>	<input type="checkbox"/>			0.002~20 N·m						
		<input type="checkbox"/>	<input type="checkbox"/>	1.00~1500 N·m						
		<input type="checkbox"/>	<input type="checkbox"/>	0.3~500 N·m						

	Model	Page	Power source			COM type	
			AC adapter	Internal battery	Dry cell battery	USB	RS232C
	WDI series	5		○		○	○
	DI-9M series	7		○		○	△
	CD series	9		○		○	△
	NDI series	11	○		○	○	○
	DI-4B-25	13		○		○	△
	DWT-200	15			○		
	WDIS-IP series	17	○		○	○	○
	WDISR-IP series			○			
	WDIS-IPS series	19	○		○	○	○
	WDISR-IPS series			○			
	WIMS-IP series	21		○		○	○
	DI-1M-IP series	23		○		○	△

Torque Tester *WDI series*

Electric screwdriver

Torque driver

Torque wrench



This series are available for various tightening tools.

WDI-10HR / 100HR allows selection of measurement joints from SJ joint or OW joint.

Features

- Easy-to-read color LCD display
- Various communication commands are available
- High resolution mode (only for WDI-10HR/100HR)
- Equipped with RS232C and USB port

Ordering number

Model - Measurement joint - Pack age - Destina tion

Model	WDI-10HR	WDI-100HR	WDI-250
Measurement Range			
Normal	0.020~1.000 N·m	0.20~10.00 N·m	0.20~25.00 N·m
High resolution	2.0~999.9 mN·m	0.020~9.999 N·m	-
Accuracy	±0.5% (If 499 digit or less, ±3 digit.)		
Power	Internal battery (Ni-MH)		
Dimensions	160(W) × 145(D) × 58(H)		
Accessories	AC adapter 6A-061WP12		

If order OW joint	Measurement joint OW-025	Measurement joint OW-20
	Measurement joint OW-10	Measurement joint OW-60
	Cube joint SC-1	Cube joint SC-2

* Each measurement joint comes with 2 spare screws.

If order SJ joint	Measurement joint SJ-10K	Measurement joint SJ-50	Measurement joint SJ-200
	Measurement joint SJ-10K	Measurement joint SJ-10K	Measurement joint SJ-50
	HEX attachment HS6-M3 (X3)	HEX attachment HS6-M3 (X3)	HEX attachment HS6-M4 (X3)
	Joint cap W-CAP-13	HEX attachment HS6-M4 (X3)	Joint cap W-CAP-13
	Grease JT-GREASE	Joint cap W-CAP-13 (X2)	Grease JT-GREASE
	Bit(4-pack) H6BIT-SET	Grease JT-GREASE	Socket bit H17SCKTBIT-A20
	Cube joint SC-1	Bit(4-pack) H6BIT-SET	Bit(4-pack) H6BIT-SET
		Cube joint SC-2	Cube joint SC-3

Product specification detail

Measurement joint

Code	OW	SJ
	OW joint	SJ joint
Contents		

Package

Code	A	C
	Attache case	Cardboard case
Contents		

Destination

Code	Jx	Ox
Contents & measurement unit	(Used in Japan only) SI unit (N·m)	(Used in outside of Japan) SI unit (N·m) Weight unit (kgf·cm) Yard-pound unit (lbf·in)

* x specifies the AC adapter plug.

Code	1	2	3	4	5
Plug type	A type	A type (China)	C type	F type	G type

Accessories (OW joint type)



Accessories (SJ joint type)



Torque Tester *DI-9M series*



Electric screwdriver

Torque driver



Come with OW joint that do not require rewinding

DI-9M-08 / 8 is a torque tester which is ideal for daily inspections of electric drivers and torque drivers.

Features

- Equipped with pass/fail function
- Displays average, maximum and minimum value
- Selectable measurement units
- Memory size is 800 data
- Equipped with USB port

Ordering number

Model - Destination

Model	DI-9M-08	DI-9M-8
Measurement Range	2.0~800.0 mN·m	0.020~8.000 N·m
Accuracy	±0.5% (If 499 digit or less, ±3 digit.)	
Power	Internal battery (Ni-MH)	
Dimensions	160(W) × 125(D) × 55(H)	
Accessories	Measurement joint OW-025 Measurement joint OW-10	Measurement joint OW-20 Measurement joint OW-60
	Cube joint SC-2 AC adapter 6A-061WP12	

* Each measurement joint comes with 2 spare screws.

Product specification detail

Destination

Code	Jx	Ox
Contents & measurement unit	(Used in Japan only) SI unit (N·m)	(Used in outside of Japan) SI unit (N·m) Weight unit (kgf·cm) Yard-pound unit (lbf·in)

* x specifies the AC adapter plug.

Code	1	2	3	4	5
Plug type	A type	A type (China)	C type	F type	G type

Accessories

OW joint



[p.42]

Cube joint



[p.43]

AC adapter



[p.41]

Torque Tester CD series



Electric screwdriver



Come with SJ joints for conventional measurement methods

CD-10M / 100M is a torque tester which is ideal for daily inspections of electric drivers.

Features

- Equipped with pass/fail function
- Displays average, maximum and minimum value
- Selectable measurement units
- Memory size is 800 data
- Equipped with USB port

Ordering number

Model - Destination

Model	CD-10M	CD-100M
Measurement Range	0.010~1.000 N·m	0.10~10.00 N·m
Accuracy	±0.5% (If 199 digit or less, ±2 digit.)	
Power	Internal battery (Ni-MH)	
Dimensions	160(W) × 125(D) × 55(H)	
Accessories	Measurement joint SJ-10 HEX attachment HS5-M3 (X3) Joint cap W-CAP-13 Grease JT-GREASE Bit(4-pack) H5BIT-SET	Measurement joint SJ-50 Measurement joint SJ-10K HEX attachment HS6-M3 (X3) HEX attachment HS6-M4 (X3) Joint cap W-CAP-13 (X2) Grease JT-GREASE Bit(4-pack) H6BIT-SET
	AC adapter 6A-061WP12	

Product specification detail

Destination

Code	Jx	Ox
Contents & measurement unit	(Used in Japan only) SI unit (N·m)	(Used in outside of Japan) SI unit (N·m) Weight unit (kgf·cm) Yard-pound unit (lbf·in)

* x specifies the AC adapter plug.

Code	1	2	3	4	5
Plug type	A type	A type (China)	C type	F type	G type

Accessories

SJ joint



[p.42]

HEX attachment



[p.43]

Joint cap



* Attached to SJ joint

[p.43]

Grease



[p.43]

Bit (4-pack)



[p.44]

AC adapter



[p.41]

Torque Tester *NDI series*



Electric screwdriver

Torque driver



Integrate a clock function ideal for traceability

NDI-80CN / 800CN is a torque tester which is ideal for daily inspections of electric drivers and torque drivers.

Features

- Easy-to-read color LCD display
- Record "measurement date" and "measurement time" together
- Advanced external control functions (Published the communication I/F as well)
- Powered by AC adapter (or dry cell battery)
- Equipped with RS232C and USB port

Ordering number

Model - OW - A - Destination

Model	NDI-80CN	NDI-800CN
Measurement Range	2.0~800.0 mN·m	0.020~8.000 N·m
Accuracy	±0.5% (If 499 digit or less, ±3 digit.)	
Power	AC adapter (or dry cell battery)	
Dimensions	160(W) × 145(D) × 58(H)	
Accessories	Measurement joint OW-025 Measurement joint OW-10 Cube joint SC-1	Measurement joint OW-20 Measurement joint OW-60 Cube joint SC-2
	USB CABLE USB-ECOM510 AC adapter 6A-061WP12 Dry cell battery (4 pieces)	

* Each measurement joint comes with 2 spare screws.

Product specification detail

Destination

Code	Jx	Ox
Contents & measurement unit	(Used in Japan only) SI unit (N·m)	(Used in outside of Japan) SI unit (N·m) Weight unit (kgf·cm) Yard-pound unit (lbf·in)

* x specifies the AC adapter plug.

Code	1	2	3	4	5
Plug type	A type	A type (China)	C type	F type	G type

Accessories

OW joint



[p.42]

Cube joint



[p.43]

USB cable



[p.49]

AC adapter



[p.41]

Dry cell battery



Torque Tester **DI-4B-25**



Electric impact tool

Oil pulse tool

Air impact tool

Electric screwdriver



Manage the blow force and number that affect tightening

DI-4B-25 is a torque tester ideal for daily inspections of impact tool and electric driver.

Features

- Easy-to-see high brightness LED
- Simultaneously measure the blow force and blow number
- Come with the soft and hard joint
- Equipped with USB port

Ordering number

Model - Destination

Model	DI-4B-25
Measurement range	
Except impact tool	0.3~25.00 N·m
Impact tool	0.3~15.00 N·m (Note)
Accuracy	±0.5% (If 499 digit or less, ±3 digit.)
Power	Internal battery (Ni-MH)
Dimensions	150(W) × 220(D) × 74(H)
Accessories	Measurement joint HEX14-H250 Measurement joint HEX14-S250 Grease JT-GREASE Socket bit H17SCKTBIT-A20 HEX socket H17SOCKET-SQ9.5 AC adapter 6A-061WP12

(Note) When using an impact tool, please make sure that the tightening torque value of used tool does not exceed the measurement range of the tester.

Product specification detail

Destination

Code	Jx	Ox
Contents & measurement unit	(Used in Japan only) SI unit (N·m)	(Used in outside of Japan) SI unit (N·m) Weight unit (kgf·cm) Yard-pound unit (lbf·in)

* x specifies the AC adapter plug.

Code	1	2	3	4	5
Plug type	A type	A type (China)	C type	F type	G type

Accessories

HEX14 joint



[p.42]

Grease



[p.43]

Socket bit



[p.45]

HEX socket



[p.45]

AC adapter



[p.41]



Simple model for torque wrench management

DWT-200 is a torque tester which is ideal for daily inspections of torque wrench.

Features

- Easy-to-see high brightness LED
- Ideal for work training

PP Mode	Measure the maximum torque
PD Mode	Measure the torque when feel a click

- Powered by dry cell battery

Ordering number

Model - Destination

Model	DWT-200
Measurement Range	7.0~200.0 N·m
Accuracy	±0.5% (If 499 digit or less, ±3 digit.)
Power	Dry cell battery
Dimensions	200(W) × 120(D) × 96(H)
Accessories	Conversion adapter BAE-34 Dry cell battery (4 pieces)

Product specification detail

Destination

Code	Jx	Ox
Contents & measurement unit	(Used in Japan only) SI unit (N·m)	(Used in outside of Japan) SI unit (N·m) Weight unit (kgf·cm) Yard-pound unit (lbf·in)

Accessories

Conversion adapter



[p.45]

Dry cell battery



For managing the tightening tools (separated type)

Torque Tester *WDIS/WDISR-IP series*

CE

Torque wrench

Nut runner

Torque driver



Prepare the "wide measurement range", "5 kinds of socket size"

Enable to choose the indicator to suit the usage scene

Power source can be selected from either AC adapter (WDIS) or internal battery (WDISR)

Features

- Easy-to-read color LCD display
- Compact type not required a lot of space
- Various communication commands are available
- Choice of power source and detector cable length
- Equipped with RS232C and USB port

Ordering number

Model - Detector cable - Pack age - Destina tion

Model	WDIS-IP05	WDIS-IP5	WDIS-IP50	WDIS-IP200	WDIS-IP500	WDIS-IP1500
Measurement Range	2.0~500.0 mN·m	0.020~5.000 N·m	0.20~50.00 N·m	2.0~200.0 N·m	2.0~500.0 N·m	20~1500 N·m
Accuracy	±0.5% (If 499 digit or less, ±3 digit.)					
Power	AC adapter (or dry cell battery) * Tester power will be interlocked with external power source					

Model	WDISR-IP05	WDISR-IP5	WDISR-IP50	WDISR-IP200	WDISR-IP500	WDISR-IP1500
Measurement Range	2.0~500.0 mN·m	0.020~5.000 N·m	0.20~50.00 N·m	2.0~200.0 N·m	2.0~500.0 N·m	20~1500 N·m
Accuracy	±0.5% (If 499 digit or less, ±3 digit.)					
Power	Internal battery (Ni-MH)					

Dimensions	Indicator : 103(W) X 108(D) X 38(H) , Detector : See to p.57					
Accessories	Detector cable Rubber foot B8-4 AC adapter 6A-061WP12				Handle CPH-P-TB8 (X2)	

Product specification detail

Detector cable

Code	L1	L2	L4
	0.9m (10P-1MF)	1.9m (10P-2MF)	3.9m (10P-4MF)
Contents			

Package

Code	A	C
	Attache case	Cardboard case
Contents		

* For IP200 / 500 / 1500, only cardboard is available

Destination

Code	Jx	Ox
Contents & measurement unit	(Used in Japan only) SI unit (N·m)	(Used in outside of Japan) SI unit (N·m) Weight unit (kgf·cm) Yard-pound unit (lbf·in)

* x specifies the AC adapter plug.

Code	1	2	3	4	5
Plug type	A type	A type (China)	C type	F type	G type

Accessories

Detector cable



[p.47]

Rubber foot



[p.49]

Handle (IP1500)



[p.49]

AC adapter



[p.41]

Torque Tester **WDIS/WDISR-IPS series**

Automatic or semi automatic screw driver



Detector which is down sized for automation facility
Enable to choose the indicator to suit the usage scene

Power source can be selected from either AC adapter (WDIS) or internal battery (WDISR)

Features

- Easy-to-read color LCD display
- Prepare various measurement range
- Various communication commands are available
- Choice of power source and detector cable length
- Equipped with RS232C and USB port

Ordering number



Model	WDIS-IPS05C	WDIS-IPS5C	WDIS-IPS20CL
Measurement Range	2.0~500.0 mN·m	0.020~5.000 N·m	0.20~20.00 N·m
Accuracy	±0.5% (If 499 digit or less, ±3 digit.)		
Power	AC adapter (or dry cell battery) * Tester power will be interlocked with external power source		

Model	WDISR-IPS05C	WDISR-IPS5C	WDISR-IPS20CL
Measurement Range	2.0~500.0 mN·m	0.020~5.000 N·m	0.20~20.00 N·m
Accuracy	±0.5% (If 499 digit or less, ±3 digit.)		
Power	Internal battery (Ni-MH)		

Dimensions	Indicator : 103(W) X 108(D) X 38(H) , Detector : See to p.57		
Accessories	Measurement joint OW-025 Cube joint SC-1	Measurement joint OW-10 Cube joint SC-2	Measurement joint OW-20 Cube joint SC-3
	Detector cable Rubber foot B8-4 AC adapter 6A-061WP12		

* Each measurement joint comes with 2 spare screws.

Product specification detail

Detector cable

Code	L1	L2	L4
	1m (10P-1MF)	2m (10P-2MF)	4m (10P-4MF)
Contents			

Package

Code	A	C
	Attache case	Cardboard case
Contents		

Destination

Code	Jx	Ox
Contents & measurement unit	(Used in Japan only) SI unit (N·m)	(Used in outside of Japan) SI unit (N·m) Weight unit (kgf·cm) Yard-pound unit (lbf·in)

* x specifies the AC adapter plug.

Code	1	2	3	4	5
Plug type	A type	A type (China)	C type	F type	G type

Accessories

OW joint



[p.42]

Cube joint



[p.43]

Detector cable



[p.47]

Rubber foot



[p.49]

AC adapter



[p.41]

Torque Tester *WIMS-IP series*



- Electric impact tool
- Oil pulse tool
- Air impact tool
- Torque wrench



Measuring sensitivity can be changed.

It is possible to judge the passing of torque and number of blows.

WIMS series is a torque tester ideal for daily inspections of impact tool and torque wrench. It is also possible to check the actual tightening torque of the torque wrench for operator training.

Features

- Easy-to-understand color LCD.
- Various commands for external control.
- Measures the number of blows at the same time as the torque.
- Measurement sensitivity can be changed.
- Save up to 10 different setting values.
- Two types of communication ports (USB/RS232C).

Ordering number



Model	WIMS-IP50	WIMS-IP200	WIMS-IP500	WIMS-IP1500
Measurement Range				
Except impact tool	1.00 ~ 50.00 N·m	10.0 ~ 200.0 N·m	10.0 ~ 500.0 N·m	100 ~ 1500 N·m
Impact tool (Note)	1.00 ~ 30.00 N·m	10.0 ~ 120.0 N·m	10.0 ~ 300.0 N·m	100 ~ 600 N·m
Accuracy	±0.5% (If 499 digit or less, ±3 digit.)			
Power	Internal battery (Ni-MH)			
Dimensions	Indicator : 103(W) X 108(D) X 38(H) Detector : See to p.57			
Accessories	Socket adapter FNA-3D	Conversion socket NA34	Conversion socket NA46	Conversion socket NA48
	Detector cable Rubber foot B8-4 AC adapter 6A-061WP12			Handle CPH-P-TB8 (X2)

(Note) When using an impact tool, please make sure that the tightening torque value of used tool does not exceed the measurement range of the tester.

Product specification detail

Detector cable

Code	L1	L2	L4
	0.9m (10P-1MF)	1.9m (10P-2MF)	3.9m (10P-4MF)
Contents			

Package

Code	A	C
Contents	Attache case 	Cardboard case 

* For IP200 / 500 / 1500, only cardboard is available

Destination

Code	Jx	Ox
Contents & measurement unit	(Used in Japan only) SI unit (N·m)	(Used in outside of Japan) SI unit (N·m) Weight unit (kgf·cm) Yard-pound unit (lbf·in)

* x specifies the AC adapter plug.

C o d e	1	2	3	4	5
Plug type	A type	A type (China)	C type	F type	G type

Accessories

Detector cable



[p.47]

Rubber foot



[p.49]

Handle (IP1500)



[p.49]

AC adapter



[p.41]

Socket adapter



[p.46]

Conversion socket



[p.46]

Torque Tester *DI-1M-IP series*



Electric impact tool

Oil pulse tool

Air impact tool

Torque wrench



Manage the blow force and number that affect tightening

DI-1M-IP series is a torque tester ideal for daily inspections of impact tool and torque wrench.

Features

- Easy-to-see high brightness LED
- Simultaneously measure the blow force and blow number
- Equipped with USB port

Ordering number

Model

Detector cable

Destination

Model	DI-1M-IP50	DI-1M-IP200	DI-1M-IP500
Measurement range			
Except impact tool	0.30~50.00 N·m	3.0~200.0 N·m	3.0~500.0 N·m
Impact tool	0.30~30.00 N·m ※	3.0~120.0 N·m ※	3.0~300.0 N·m ※
Accuracy	±0.5% (If 499 digit or less, ±3 digit.)		
Power	Internal battery (Ni-MH)		
Dimensions	Indicator : 150(W) X 115(D) X 48(H) Detector : See to p.57		
Accessories	Detector cable AC adapter 6A-061WP12		

(Note) When using an impact tool, please make sure that the tightening torque value of used tool does not exceed the measurement range of the tester.

Product specification detail

Detector cable

Code	L1	L2	L4
	1m (10P-1M)	2m (10P-2M)	4m (10P-4M)
Contents			

Destination

Code	Jx	Ox
Contents & measurement unit	(Used in Japan only) SI unit (N·m)	(Used in outside of Japan) SI unit (N·m) Weight unit (kgf·cm) Yard-pound unit (lbf·in)

* x specifies the AC adapter plug.

Code	1	2	3	4	5
Plug type	A type	A type (China)	C type	F type	G type

Accessories

Detector cable



[p.48]

AC adapter









[p.41]

Index (Tightening tools, other)



Tightening (Wrench type)	Tightening (Driver type)	Slip torque inspection	Friction torque inspection	0.001	0.01	0.1	1	10	100
○							0.2~120 N·m		
	○				0.002~4 N·m				
	○				0.02~1.5 N·m				
	○			0.0002~10 N·m					
		○			0.0015~15 N·m				
	○		○		0.002~2 N·m				

	Model	Page	Power source				COM type	
			AC power	AC adapter	Internal battery	Dry cell battery	USB	RS232C
	DIW series	27			○		○	△
	DID series	29			○		○	△
	NDID-150CN	31			○			△
	WDIS-RL series	33		○		○	○	○
	WDISR-RL series				○			
	DI-12 series	35	○				○	
	NTS7series	37		○			○	○

Torque Wrench *DIW series*

Bolt tightening



No hand force points for stable tightening operations

High operability to check tightening torque

DIW series is a digital torque wrench which is ideal for the bolt tightening .

Features

- No hand force point
- Square drive parts is rotatable
- Equipped with pass/fail function
- Equipped with the tightening counter function
- Memory size is 800 data
- Equipped with USB port

Ordering number

Model - Destination

Original mechanism

Easy to work due to check tightening torque by the rotating mechanism

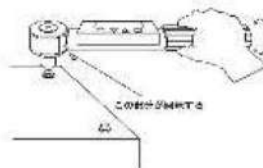

Model	DIW-15	DIW-20	DIW-75	DIW-120
Measurement range	0.20~15.00 N·m	0.20~20.00 N·m	0.20~75.00 N·m	2.0~120.0 N·m
Accuracy	±0.5% (If 199 digit or less, ±1 digit.)	±0.5% (If 499 digit or less, ±3 digit.)		±0.5% (If 199 digit or less, ±1 digit.)
Power	Internal battery (Ni-MH)			
Dimensions	See to p.56			
Square drive	6.35 sq.	9.5 sq.	9.5 sq.	12.7 sq.
Accessories	One way drive OWD-15	One way drive OWD-20	One way drive OWD-75	Ratchet adapter 4755
	AC adapter 6A-061WP12			

Product specification detail

Destination

Code	Jx	Ox
Contents & measurement unit	(Used in Japan only) SI unit (N·m)	(Used in outside of Japan) SI unit (N·m) Weight unit (kgf·cm) Yard-pound unit (lbf·in)

* x specifies the AC adapter plug.

Code	1	2	3	4	5
Plug type	A type	A type (China)	C type	F type	G type

Accessories

One way drive



[p.46]

Ratchet adapter



[p.46]

AC adapter



[p.41]

Screw tightening



Light and sound notification, ideal for screw tightening management

DID-05 has a built-in one way function / DID-4 comes with a one way bit holder

Features

- Equipped with pass/fail function
- Selectable measurement units
- Equipped with the tightening counter function
- Memory size is 800 data
- Equipped with USB port

Ordering number

Model - Destination

Model	DID-05	DID-4
Measurement range	2.0~500.0 mN·m	0.020~4.000 N·m
Accuracy	±0.5% (If 499 digit or less, ±3 digit.)	
Power	Internal battery (Ni-MH)	
Dimensions	See to p.56	
Socket	Φ4 (HIOS shank)	HEX 6.35 (using bit holder)
Accessories	Bit (#1) V05+1X4X44 Bit (#1) D73+1X4X40	Bit (#1) B35+1X50H Bit (#2) B35+2X50G Bit holder 10-4141 One way bit holder OWB-4141
	AC adapter 6A-061WP12	

Product specification detail

Destination

Code	Jx	Ox
Contents & measurement unit	(Used in Japan only) SI unit (N·m)	(Used in outside of Japan) SI unit (N·m) Weight unit (kgf·cm) Yard-pound unit (lbf·in)

* x specifies the AC adapter plug.

Code	1	2	3	4	5
Plug type	A type	A type (China)	C type	F type	G type

Accessories

**Bit
(DID-05)**



[p.44,45]

**Bit
(DID-4)**



[p.44]

Bit holder



[p.47]

**One way
bit holder**



[p.47]

AC adapter



[p.41]



Digital torque driver which is equipped the click mechanism

NDID-150CN is rotary-slip at a specified torque and displays the tightening torque by digital.

Features

- Grip rotates the specified torque
- Record "measurement date" and "measurement time" together
- Equipped with the tightening counter function
- Record to USB flash drive (400 records to the body)
- Light and sound notification

Ordering number

Model

Destination

Model	NDID-150CN
Measurement range	0.020~1.500 N·m
Accuracy	±(1.0%+1digit) * Guaranteed in the range of 0.300 to 1.500 N·m
Power	Internal battery (Ni-MH)
Length overall	205 mm
Socket	HEX 6.35
Accessories	Bit (#1) B33+1X25.4H Bit (#2) B33+2X25.4H HEX wrench TWH-16 USB flash drive UFD-P4GBK AC adapter 6A-061WP12

Product specification detail

Destination

Code	Jx	Ox
Contents & measurement unit	(Used in Japan only) SI unit (N·m)	(Used in outside of Japan) SI unit (N·m) Weight unit (kgf·cm) Yard-pound unit (lbf·in)

* x specifies the AC adapter plug.

Code	1	2	3	4
Plug type	A type	A type (China)	C type	F type

Accessories

Bit



[p.44]

HEX wrench



[p.47]

USB flash drive



[p.49]

AC adapter



[p.41]

Tightening tools (separated type)



Torque Tester **WDIS/WDISR-RL series**

Screw tightening



Ideal for tightening management of M1 ~ M6 screw

Power source can be selected from either AC adapter (WDIS) or internal battery (WDISR)

Features

- Easy-to-read color LCD display
- Various communication commands are available
- Choice of power source and detector cable length
- Equipped with RS232C and USB port

Ordering number

Model	Detector cable	Pack age	Destina tion
-------	----------------	----------	--------------

Model	WDIS-RL005	WDIS-RL05	WDIS-RL6	WDIS-RL10
Measurement Range	0.20~50.00 mN·m *0.05mN·m incremeent	2.0~500.0 mN·m	0.020~6.000 N·m	0.20~10.00 N·m
Accuracy	±2.0% or 0.3mN·m	±0.5% (If 499 digit or less, ±3 digit.)		
Power	AC adapter (or dry cell battery) * Tester power will be interlocked with external power source			

Model	WDISR-RL005	WDISR-RL05	WDISR-RL6	WDISR-RL10
Measurement Range	0.20~50.00 mN·m *0.05mN·m incremeent	2.0~500.0 mN·m	0.020~6.000 N·m	0.20~10.00 N·m
Accuracy	±2.0% or 0.3mN·m	±0.5% (If 499 digit or less, ±3 digit.)		
Power	Internal battery (Ni-MH)			

Dimensions	Indicator : 103(W) X 108(D) X 38(H) , Detector : See to p.58		
Socket	Φ4 (HIOS shank)		HEX 6.35 (using bit holder)
Accessories	Bit (#0) D73+0X2.5X40 Bit (#1) D73+1X4X40		Bit (#1) B35+1X50H Bit (#2) B35+2X50G Bit holder 10-4141 One way bit holder OWB-4141
			Auxiliary handle PSAGN13-100 (X2)
	Detector cable Rubber foot B8-4 AC adapter 6A-061WP12		

Product specification detail

Detector cable

Code	L1	L2	L4
	0.9m (10P-1MF)	1.9m (10P-2MF)	3.9m (10P-4MF)
Contents			

Package

Code	A	C
	Attache case	Cardboard case
Contents		

Destination

Code	Jx	Ox
Contents & measurement unit	(Used in Japan only) SI unit (N·m)	(Used in outside of Japan) SI unit (N·m) Weight unit (kgf·cm) Yard-pound unit (lbf·in)

* x specifies the AC adapter plug.

Code	1	2	3	4	5
Plug type	A type	A type (China)	C type	F type	G type

Accessories

Bit
(RL005/05)



[p.44]

Bit
(RL6/10)



[p.44]

Bit holder



[p.47]

One way bit holder



[p.47]

Auxiliary handle
(RL10)



[p.47]

Detector cable



[p.47]

Rubber foot



[p.49]

AC adapter



[p.41]

Slip Torque Inspection



Slip torque tester DI-12 series

Screw, bolt inspection



Ideal for inspection of tightened screws

DI-12 series inspect the tightening torque of screw based on the retightening torque method.

Features

- Can estimate tightening torque value
- Stable inspection due to motorized drive
- Automatically stops when slip is detected
- Equipped with USB port

Ordering number

Model

Detector cable

Destination

Model	DI-12-SL02	DI-12-SL4	DI-12-SL15
Measurement range	1.5~200.0 mN·m	0.030~4.000 N·m	0.30~15.00 N·m
Accuracy	±2.0% (If 499 digit or less, ±10 digit.)	±1.0% (If 499 digit or less, ±5 digit.)	
Power	AC power		
Length overall	Indicator : 166(W) X 142(D) X 48(H)		
Socket	Φ4	HEX 6.35	Square drive 6.35
Accessories	Bit (#0) V05+0X4X44	Bit (#1) B35+1X50H Bit (#2) B35+2X50G	-
	Detector cable Power cable PWC		

Product specification detail



Detector cable

Code		L1	L2	L4
Contents	SL02 SL4	1m (10P-1M)	2m (10P-2M)	4m (10P-4M)
				
	SL15	1m (SL-7P-1M)	2m (SL-7P-2M)	4m (SL-7P-4M)
				

Destination

Code	Jx	Ox
Contents & measurement unit	(Used in Japan only) SI unit (N·m)	(Used in outside of Japan) SI unit (N·m) Weight unit (kgf·cm) Yard-pound unit (lbf·in)

* x specifies the AC adapter plug.

Code	1	3
Plug type	A type 	C type 

Accessories

Bit
(SL02)



[p.45]

Bit
(SL4)



[p.44]

Detector cable
(SL02/SL4)



[p.48]

Detector cable
(SL15)



[p.48]

Power cable



[p.41]

Rotation friction torque tester NTS7 series

Friction torque

Opening torque

screw tightening



Inspectable with friction torque or rotation angle

NTS7 series is ideal for managing frictional torque of various rotating objects.

Features

- Easy-to-read color LCD display
- Various communication commands are available
- Changeable rotation speed
(5 to 50 RPM, 5 RPM step)
- Can be tightened at constant torque
- Tester power will be interlocked with external power source
- Equipped with RS232C and USB port

Ordering number

Model - L2 - A - **Destination**

* To order HEX6.35 specification, please see below.

Model - L2 - A - **Destination** + H635

Model	NTS7-RT05	NTS7-RT05(+H635) (Note 1)	NTS-RT2
Measurement range	2.0~500.0 mN·m		0.020~2.000 N·m
Accuracy	±1.0% (If 499 digit or less, ±5 digit.)		
Power	AC adapter		
Length overall	Indicator : 103(W) X 108(D) X 38(H) Detector : See to p.58.		
Socket	Φ4 (HIOS shank)	HEX 6.35	
Accessories	Bit (#0) D73+0X2.5X40 Bit (#1) D73+1X4X40	Bit (#1) B35+1X50H Bit (#2) B35+2X50G	
	Detector cable RT-12P-2M External port cable EXT-5P-1M Rubber foot B8-4 AC adapter SMI36-24		

Product specification detail

Destination

Code	Jx	Ox
Contents & measurement unit	(Used in Japan only) SI unit (N·m)	(Used in outside of Japan) SI unit (N·m) Weight unit (kgf·cm) Yard-pound unit (lbf·in)

* x specifies the AC adapter plug.

Code	1	2	3	5
Plug type	A type	A type (China)	C type	G type

Accessories

Bit (RT05)



[p.44]

Bit (RT2)



[p.44]

Detector cable



[p.48]

External port cable



[p.49]

Rubber foot





[p.49]

AC adapter

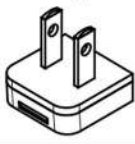
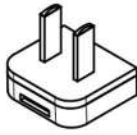
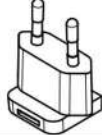

[p.41]

AC adapter 6A-061WP12

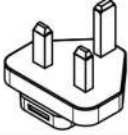

Model	6A-061WP12-1	6A-061WP12-2	6A-061WP12-3	6A-061WP12-4	6A-061WP12-5
Plug	A type 	A type (China) 	C type (Φ4) 	F type (Φ4.8) 	G type 
Rated input	AC 100~240V (50~60Hz) 0.3A or less				
Output	DC 12V 0.5A or less				
Certification	PSE, FCC, CCC, BSMI, CE			PSE, CE, UKCA, KC	
Compliant models	WDI series, DI-9M series, CD series, NDI series, DI-4B-25 WDIS/WDISR - IP series WDIS/WDISR - IPS series WDIS/WDISR - RL series DI-1M series, WIMS-IP series DIW series, DID series, NDID-150CN, WM2.4-DSUB-9S				

* As for the G plug, some models are not compatible.

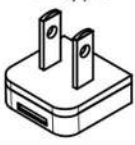
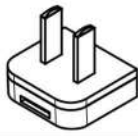
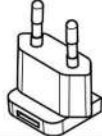
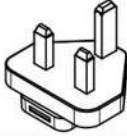
AC adapter SMI36-24

Model	SMI36-24-1	SMI36-24-2	SMI36-24-3	SMI36-24-5
Plug	A type 	A type (China) 	C type (Φ4) 	G type 
Rated input	AC 100~240V (50~60Hz) 1.0A or less			
Output	DC 24V 1.5A or less			
Certification	PSE, FCC, CCC, CE, UKCA			
Compliant models	NTS7 series			

Power cable PWC

Model	PWC-1	PWC-3
Plug	A type 	C type (Φ4) 
Compliant models	DI-12 series	

Measurement joint OW series

Model	OW-025	OW-10	OW-20	OW-60
				
Measurement range	MAX 0.25 N·m	MAX 1 N·m	MAX 2 N·m	MAX 6 N·m
Joint shape	⊕ M2.6	⊕ M3	⊕ M4	⊕ M6
Accessory	PAN, M2.6X5 (x2)	UPSET, M3X5 (X2)	UPSET, M4X5 (X2)	UPSET, M6X6 (X2)
Compliant models	WDI series DI-9M series NDI series WDIS/WDISR – IPS series			

* OW joint comes with 2 spare screws.

Measurement joint SJ series

Model	SJ-1.5	SJ-3	SJ-10	SJ-10K	SJ-50	SJ-200
						
Measurement range	MAX 0.15 N·m	MAX 0.3 N·m	MAX 1 N·m	MAX 1 N·m	MAX 5 N·m	MAX 20 N·m
Joint shape	⊕ M2.5	HEX socket (5mm)	HEX socket (5mm)	HEX socket (6mm)	HEX socket (6mm)	Hexagonal (17mm)
Accessory	–	HEX attachment HS5-M2.6 (X3) Joint cap W-CAP-10	HEX attachment HS5-M3 (x3) Joint cap W-CAP-10	HEX attachment HS6-M3 (x3) Joint cap W-CAP-13	HEX attachment HS6-M4 (x3) Joint cap W-CAP-13	–
Compliant models	WDI series CD series					

Measurement joint HEX14 series

Model	HEX14-H250	HEX14-S250
		
Measurement range	MAX 25 N·m	MAX 25 N·m
Joint shape	Hexagonal (17mm)	Hexagonal (17mm)
Compliant models	DI-4B-25	

Cube joint SC series



Model	SC-1 	SC-2 	SC-3 
Tapped hole	M1/1.2/1.4/2/3	M2.6/3/4/5/6	M4/5/6/8/10
Compliant models	WDI series DI-9M series CD series NDI series WDIS/WDISR - IPS series		

HEX attachment HS series

Model	HS5-M2.6 	HS5-M3 	HS6-M3 	HS6-M4 
Joint shape	⊕ M2.6	⊕ M3	⊕ M3	⊕ M4
Compliant measurement joint	SJ-3, SJ-10		SJ-10K, SJ-50	

Joint cap W-CAP-10/13









Model	W-CAP-10 	W-CAP-13 
Compliant measurement joint	SJ-3, SJ-10	SJ-10K, SJ-50

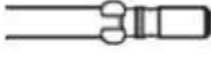

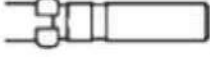



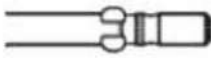

Grease JT-GREASE

Model	JT-GREASE 
Compliant measurement joint	SJ-1.5/3/10/10K/50/200 HEX14-H250/S250

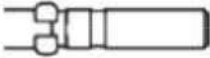

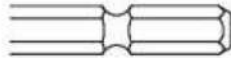



Bit H5BIT / H6BIT series

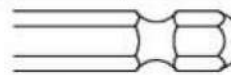

Model	H5BIT-D73	H5BIT-D76	H5BIT-B34	H5BIT-B35
Model (4-pack)	H5BIT-SET			
Bit point	 H 5 mm			
Insertion part	  ϕ 4 mm	  ϕ 5 mm	  H 5 mm	  H 6.35 mm
Compliant measurement joint	SJ-3, SJ-10			

Model	H6BIT-D73	H6BIT-D76	H6BIT-B34	H6BIT-B35
Model (4-pack)	H6BIT-SET			
Bit point	 H 6 mm			
Insertion part	  ϕ 4 mm	  ϕ 5 mm	  H 5 mm	  H 6.35 mm
Compliant measurement joint	SJ-10K, SJ-50			

Bit B33 / B35 series

Model	B33+1X2.54H	B33+2X2.54H	B35+1X50H	B35+2X50G
Bit point	\oplus No.1	\oplus No.2	\oplus No.1	\oplus No.2
Insertion part	  H 6.35 mm		  H 6.35 mm	
Compliant models	NDID-150CN		DID-4, WDIS-RL6/RL10, WDISR-RL6/RL10, DI-12-SL4, NTS7-RT05(+H635)/RT2	

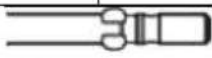
Bit D73 series

Model	D73+0X2.5X40	D73+1X4X40
Bit point	\oplus No.0	\oplus No.1
Insertion part	  ϕ 4 mm	
Compliant models	WDIS-RL005/RL05, WDISR-RL005/RL05, DID-05, NTS7-RT05	

Bit V05 series

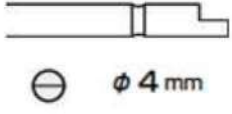

Model	V05+0X4X44	V05+1X4X44
Bit point	⊕ No.0	⊕ No.1
Insertion part	 <p>⊖ ϕ 4 mm</p>	
Compliant models	DID-05, DI-12-SL02	

Socket bit H17SCKTBIT-A20

Model	H17SCKTBIT-A20
Socket size	Hexagonal (17mm)
Insertion part	 <p>H 6.35 mm</p>
Compliant measurement joint	SJ-200, HEX14-H250, HEX14-S250

HEX socket H17SOCKET-SQ9.5



Model	H17SOCKET-SQ9.5
	
Socket size	Hexagonal (17mm)
Inlet size	9.5 sq.
Compliant measurement joint	SJ-200, HEX14-H250, HEX14-S250

Conversion adapter BAE-34

Model	BAE-34
	
Square drive	12.7 sq.
Inlet size	9.5 sq.

Socket adapter **FNA-3D**



Model	FNA-3D
Insertion part	 H 6.35 mm
Square drive	 9.5 sq.
Compliant models	WIMS-IP50 DI-1M-IP50

Conversion socket **NA series**

Model	NA34	NA46	NA48
			
Square drive	12.7 sq.	19.0 sq.	25.4 sq.
Inlet size	9.5 sq.	12.7 sq.	12.7 sq.
Compliant models	WIMS-IP200 DI-1M-IP200	WIMS-IP500 DI-1M-IP500	WIMS-IP1500

One way drive **OWD series**

Model	OWD-15	OWD-20	OWD-75
			
Square drive	6.35 sq.	9.5 sq.	9.5 sq.
Inlet size			
Compliant models	DIW-15, DID-4	DIW-20	DIW-75

Ratchet adapter **4755**

Model	4755 
Square drive	12.7 sq.
Inlet size	12.7 sq.
Compliant models	DIW-120

Bit holder 10-4141/One way bit holder OWB-4141

Model	10-4141	OWB-4141
		
Bit holder	Hexagonal (6.35mm)	
Inlet size	6.35 sq.	
Compliant models	DIW-15, DID-4, WDIS-RL6/RL10 WDISR-RL6/RL10	

Auxiliary handle PSAGN13-100

Model	PSAGN13-100
	
Handle length	100 mm
Compliant models	WDIS-RL10, WDISR-RL10

HEX wrench TWH-16

Model	TWH-16
	
Size	80 x 28 mm
Width across flat	5 mm

Detector cable 10P-XMF series

Model	10P-1MF	10P-2MF	10P-4MF
			
Cable length	0.9 m	1.9 m	3.9 m
Connector shape	Indicator side	Square type (10pin) *with ferrite core	
	Detector side	Round type (10pin)	
Compliant models	WDIS-IP/IPS/RL series, WDISR-IP/IPS/RL series, WIMS series		

Detector cable **10P-XM series**

Model		10P-1M	10P-2M	10P-4M
				
Cable length		1 m	2 m	4 m
Connector shape	Indicator side	Square type (10pin)		
	Detector side	Round type (10pin)		
Compliant models		DI-1M-IP series, DI-12-SL02/SL4		

Detector cable **SL-7P-XM series**

Model		SL-7P-1M	SL-7P-2M	SL-7P-4M
				
Cable length		1 m	2 m	4 m
Connector shape	Indicator side	Round type (7pin)		
	Detector side			
Compliant models		DI-12-SL15		

Detector cable **RT-12P-2M (A)**

Model		RT-12P-2M
		
Cable length		2 m
Connector shape	Indicator side	Square type (10pin) (With lock mechanism)
	Detector side	Round type (12pin)
Compliant models		NTS7 series

External port cable **EXT-5P-1M**

Model		EXT-5P-1M
		
Cable length		1 m
Connector shape		Square type (5pin)
Compliant models		NTS7 series

Handle **CPH-P-TB8**



Model	CPH-P-TB8 
Size	40(W) X 48(H)
Compliant models	WDIS-IP1500, WDISR-IP1500, WIMS-IP1500

Rubber foot **B8-4**

Model	B8-4 
size	Φ8 X 3.5
Compliant models	WDIS-IP/IPS/RL series, WDISR-IP/IPS/RL series NTS7 series, WIMS series

USB cable **USB-ECOM510**

Model	USB-ECOM510 
Connector	A type - Mini B
Cable length	1 m
Compliant models	NDI series

USB flash drive **UFD-P4GBK**

Model	UFD-P4GBK
Interface	USB 2.0 Compatible
	
Compliant models	NDID-150CN

Fixed stand **BH-STD**



Model	BH-STD
Compliant models	WDI series DI-9M series CD series NDI series
Dimensions	160(W) x 116(H) x 55(D)
Weight	Around 1.2kg

Fixed stand **LV-STD**



Model	LV-STD
Compliant models	WDIS-IP50/IP200/IP500/IP1500 WDISR-IP50/IP200/IP500/IP1500 WIMS-IP50/IP200/IP500/IP1500 DI-1M- IP50/IP200/IP500
Dimensions	200(W) x 200(H) x 200(D)
Weight	Around 9kg

Measurement attachment **SA series**



Model	SA2-5.5	SA2-7	SA2-8	SA2-10
Width across flat	5.5 mm	7 mm	8 mm	10 mm
Square drive	6.35 sq.			
Compliant models	WDIS-IP5/WDISR-IP5			



Model	SA3-12	SA3-13	SA3-14	SA3-17	SA3-19
Width across flat	12 mm	13 mm	14 mm	17 mm	19 mm
Square drive	9.5 sq.				
Compliant models	WDIS-IP50/WDISR-IP50				



Model	SA4-22	SA4-24	SA4-27	SA4-30
Width across flat	22 mm	24 mm	27 mm	30 mm
Square drive	12.7 sq.			
Compliant models	WDIS-IP200/WDISR-IP200/DWT-200			



Model	SA6-32	SA6-36	SA6-41
Width across flat	32 mm	36 mm	41 mm
Square drive	19 sq.		
Compliant models	WDIS-IP500/WDISR-IP500		

HT series adapter

AHT series



Model	AHT-10	AHT-12
Dimensions		
A Shaft diameter	Φ10mm	Φ12mm
Compliant models	NTS7-RT05	NTS7-RT2

Socket adapter A20BSQ series



Model	A20BSQ2	A20BSQ3	A20BSQ4
Insertion part	 H 6.35 mm		
Square drive	6.35 sq.	9.5 sq.	12.7 sq.
Compliant models	WDIS-IP05/IP5 WDISR-IP05/IP5	WDIS-IP50 WDISR-IP50	WDIS-IP200 WDISR-IP200

RS232C cable KR-LK2



Model	KR-LK2
Type	Cross
Cable length	2 m
Compliant models	WDI series WDIS-IP/IPS/RL series WDISR-IP/IPS/RL series WIMS series, NTS7 series

RS232C cable KR-M1



Model	KR-M1
Type	Straight
Cable length	1 m
Compliant models	NDI series



USB cable **KU-SLAMB520BK**



Model	KU-SLAMB520BK
Connector	A type – Mini B
Cable length	2 m
Compliant models	WDI series, NDI series WDIS-IP/IPS/RL series WDISR-IP/IPS/RL series WIMS series, DIW series, DID series, NTS7 series

USB cable **KU20-2K**



Model	KU20-2K
Connector	A type –B type
Cable length	2 m
Compliant models	CD series, DI-9M series DI-1M-IP series, DI-12 series

Measurement joint OW series

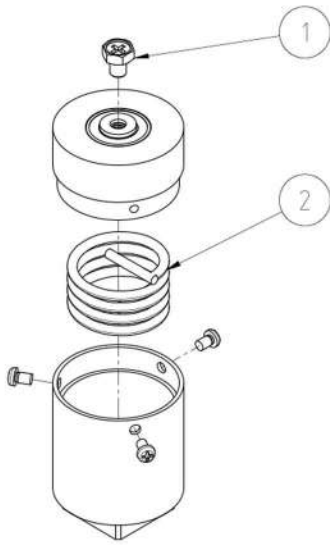

No	Compliant models	OW-025	OW-10	OW-20	OW-60
1	Screw for OW joint	PAN+2.6X5 	UPSET+3X5 	UPSET+4X5 	UPSET+6X6
2	Spring for OW joint	OW-SPG025 	OW-SPG10 	OW-SPG20 	OW-SPG60

Measurement joint SJ series

Compliant models	SJ-1.5	SJ-3	SJ-10	SJ-10K	SJ-50	SJ-200
Shaft for SJ joint	SJ-SHAFT1.5 	SJ-SHAFT3 	SJ-SHAFT10 	SJ-SHAFT50 		SJ-SHAFT200
Spring for SJ joint	SJ-SPG1.5 	SJ-SPG3 	SJ-SPG10 		SJ-SPG50 	SJ-SPG200 (5 discs)

Battery MH series / 2HR series



Model	MH1100AA5BN.0
Compliant models	WDI series DI-9M series CD series DI-4B-25 WDISR-IP/IPS/RL series WIMS series DI-1M-IP series



Model	MH800AAA4GN.0
Compliant models	DID-4 DIW series



Model	MH600AAK4BN.0
Compliant models	DID-05



Model	2HR-AAAUC
Compliant models	NDID-150CN

Thumb screw TS-B-M10X15



Model	TS-B-M10X15
Compliant models	WDI series DI-9M series CD series NDI series

RS232C output

Customization code	(Torque tester's ordering number) + RS
Compliant models	DI-9M series CD series DI-4B-25 DI-1M-IP series DIW series DID-4 NDID-150CN

Note. USB port is changed to RS232C port.

RS232C output (Baudrate 9600bps)

Customization code	(Torque tester's ordering number) + RS9600
Compliant models	DI-1M-IP series

Note. USB port is changed to RS232C port.

OW joint Screw diameter

Customization code	(OW joint's model) + Mx (Screw diameter)	
Screw diameter	OW joint's model	Changeable screw diameter
	OW-025	M2, 2.5, 3, 4
	OW-10	M2, 2.5(2.6), 3, 4, 5
	OW-20	M2, 2.5(2.6), 3, 4, 5
	OW-60	M3, 4, 5
* Tapped hole is metric coarse screw threads.		

Note. Specifications of the product accessories cannot be changed.

Screws are not included with custom products.

Dimensions



DIW series

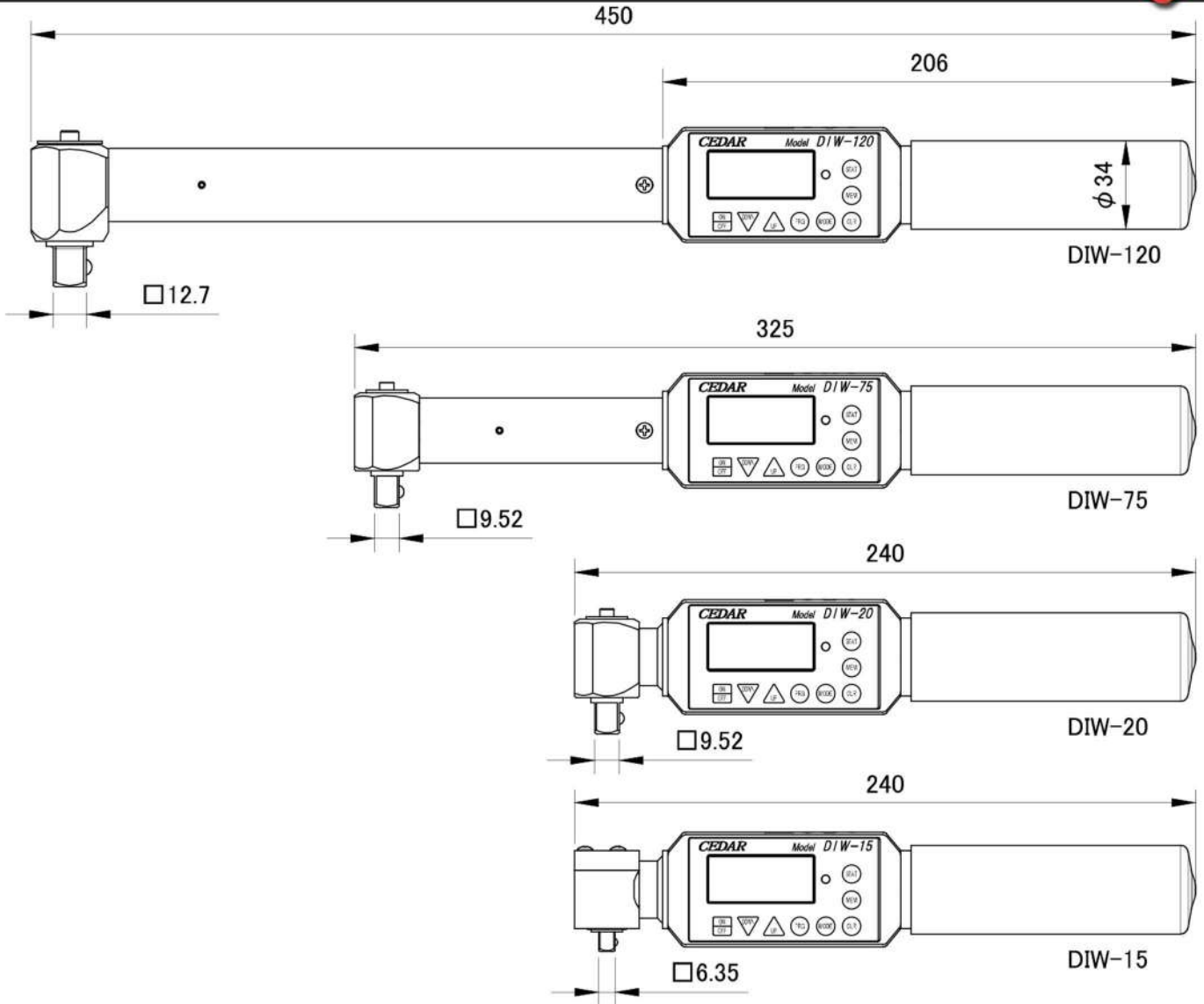

DID series

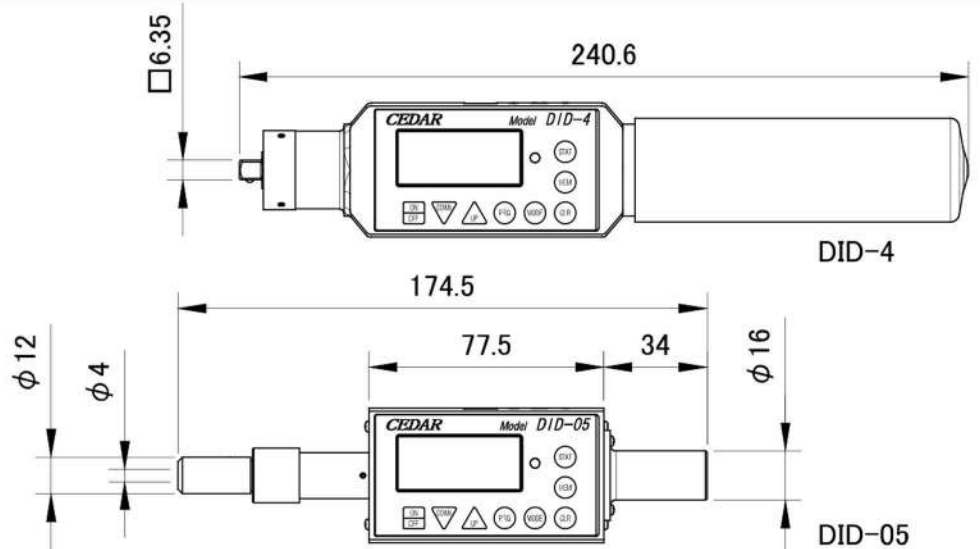

IP detector

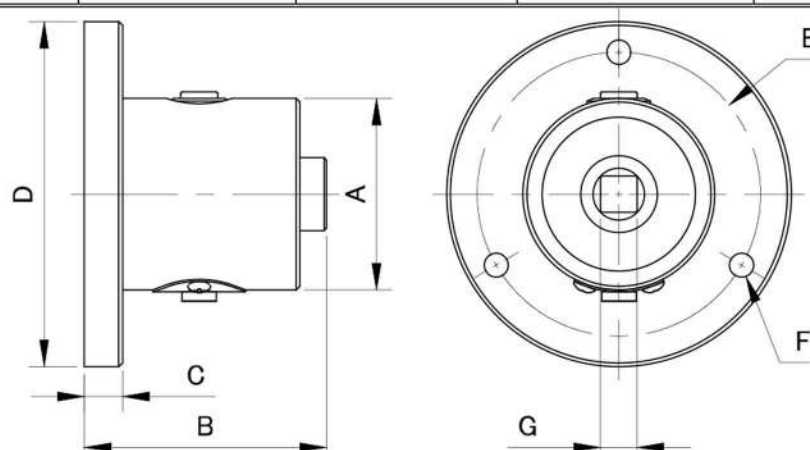
Model	IP05 / 5	IP50	IP200	IP500	IP1500
Shapes					
A Detector size	Φ40mm	Φ50mm	Φ60mm	Φ80mm	Φ100mm
B Height	41.2mm	63mm	79mm	98.5mm	102.5mm
C Thickness	5mm	10mm	15.1mm	16mm	33mm
D Flange size	Φ60mm	Φ90mm	Φ108mm	Φ140mm	Φ170mm
E Hole position	Φ50mm	Φ74mm	Φ90mm	Φ116mm	Φ140mm
F Hole size	Φ4.2mm (Every 120°)	Φ6.3mm (Every 120°)	Φ8.3mm (Every 120°)	Φ10.5mm (Every 120°)	Φ13mm (Every 60°)
G Socket	6.35sq	9.5sq	12.7sq	19sq	25.4sq
Weight	Around 200g	Around 600g	Around 1.8kg	Around 3.4kg	Around 7.8kg

IPS detector

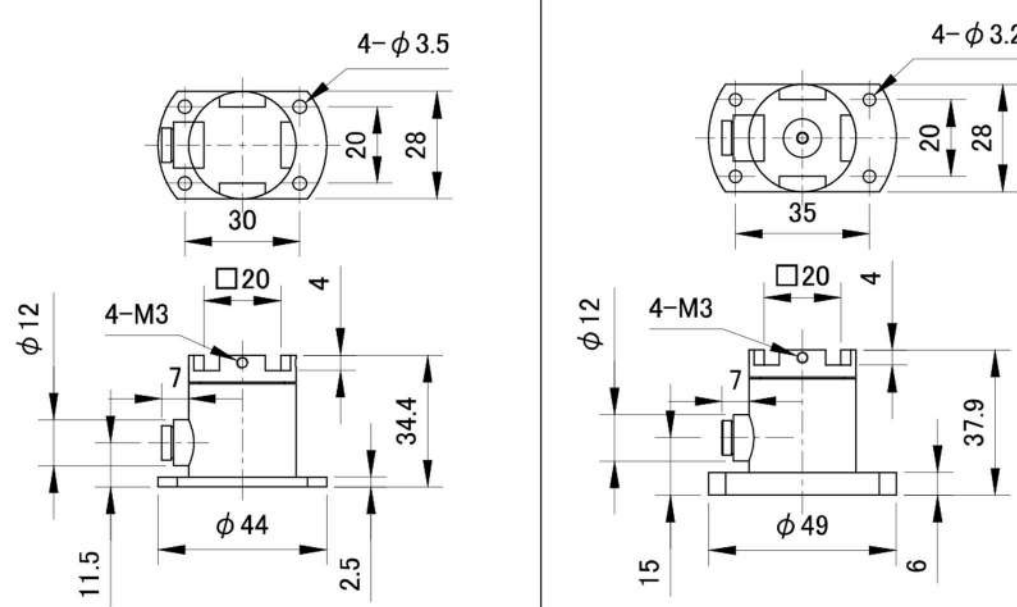
Model	IPS05C / 5C	IPS20CL
Shapes (units : mm)		

RL detector

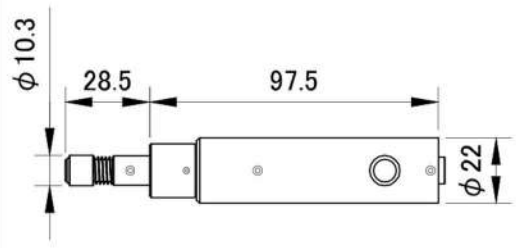
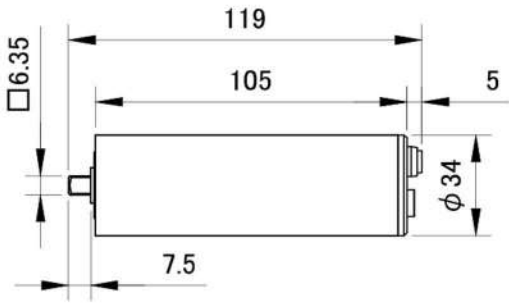
Model	RL005 / 05	RL6 / 10
Shapes (units : mm)		

RT detector

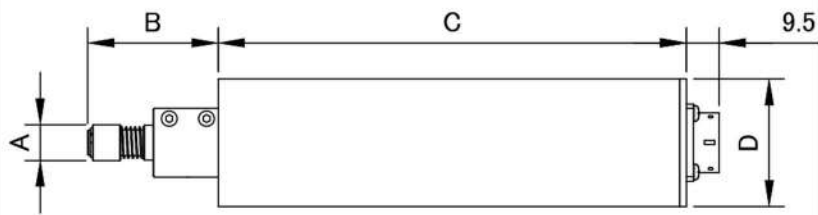
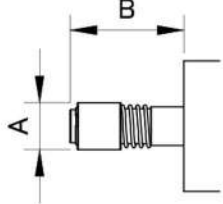
型 式	RT05	RT2	RT05(+H635)
形 状			
A 先端外径	Φ 10.3 mm	Φ 12.0 mm	Φ 13.3 mm
B 先端長さ	38.0 mm	55.5 mm	32.5 mm
C 本体長さ	135.5 mm	168.5 mm	135.5 mm
D 本体外径	Φ 37.0 mm	Φ 42.0 mm	Φ 37.0 mm